

AUFBAUANLEITUNG SET UP INSTRUCTION

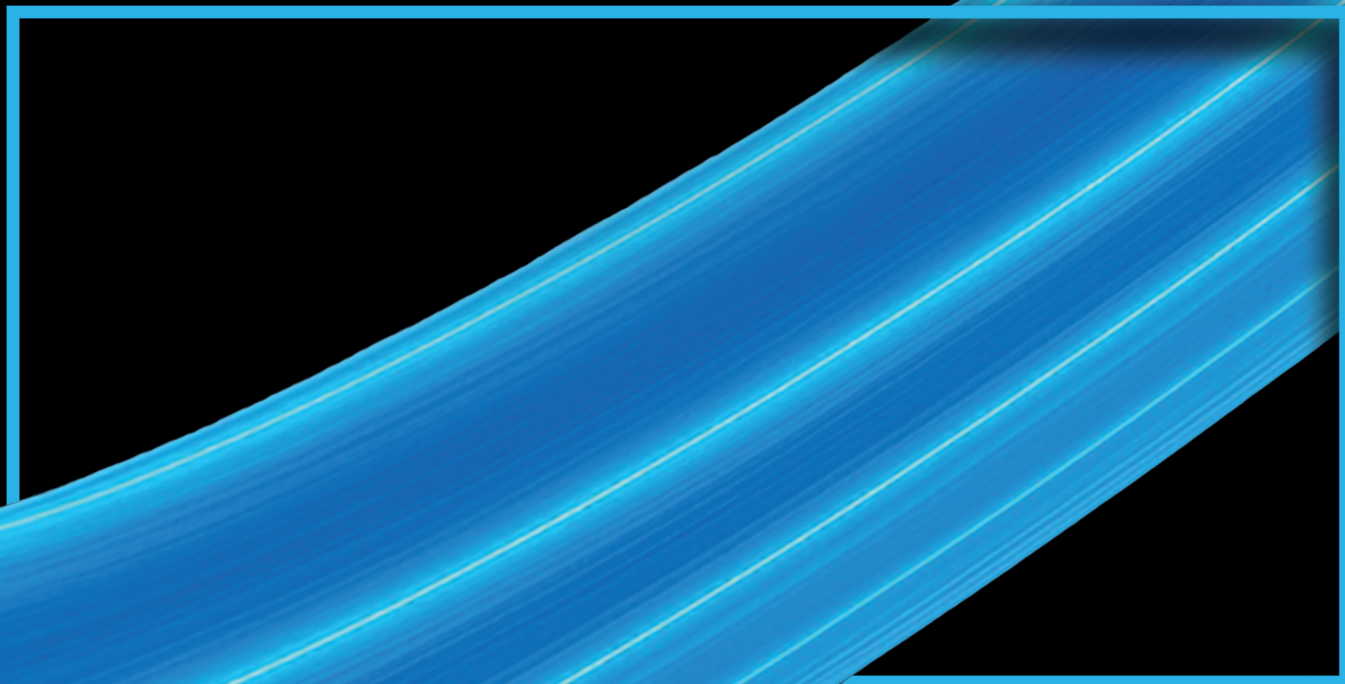

LINEUP

LINEUP

| | |
|--|-----|
| LINEUP STELE 100 x 200 250 300cm | 4 |
| Aufbauanleitung/set up instruction | |
| LINEUP 200 250 300cm x 200 250 300cm | 14 |
| Aufbauanleitung/set up instruction | |
| LINEUP SUPPORT POLE 200 250 300cm | 34 |
| Aufbauanleitung/set up instruction | |
| LINEUP GATE | 42 |
| Aufbauanleitung/set up instruction | |
| LINEUP Rotate 100 x 200 250 300cm | 58 |
| Aufbauanleitung/set up instruction | |
| LINEUP Accessories | 76 |
| Aufbauanleitung/set up instruction | |
| LINEUP Examples | 134 |

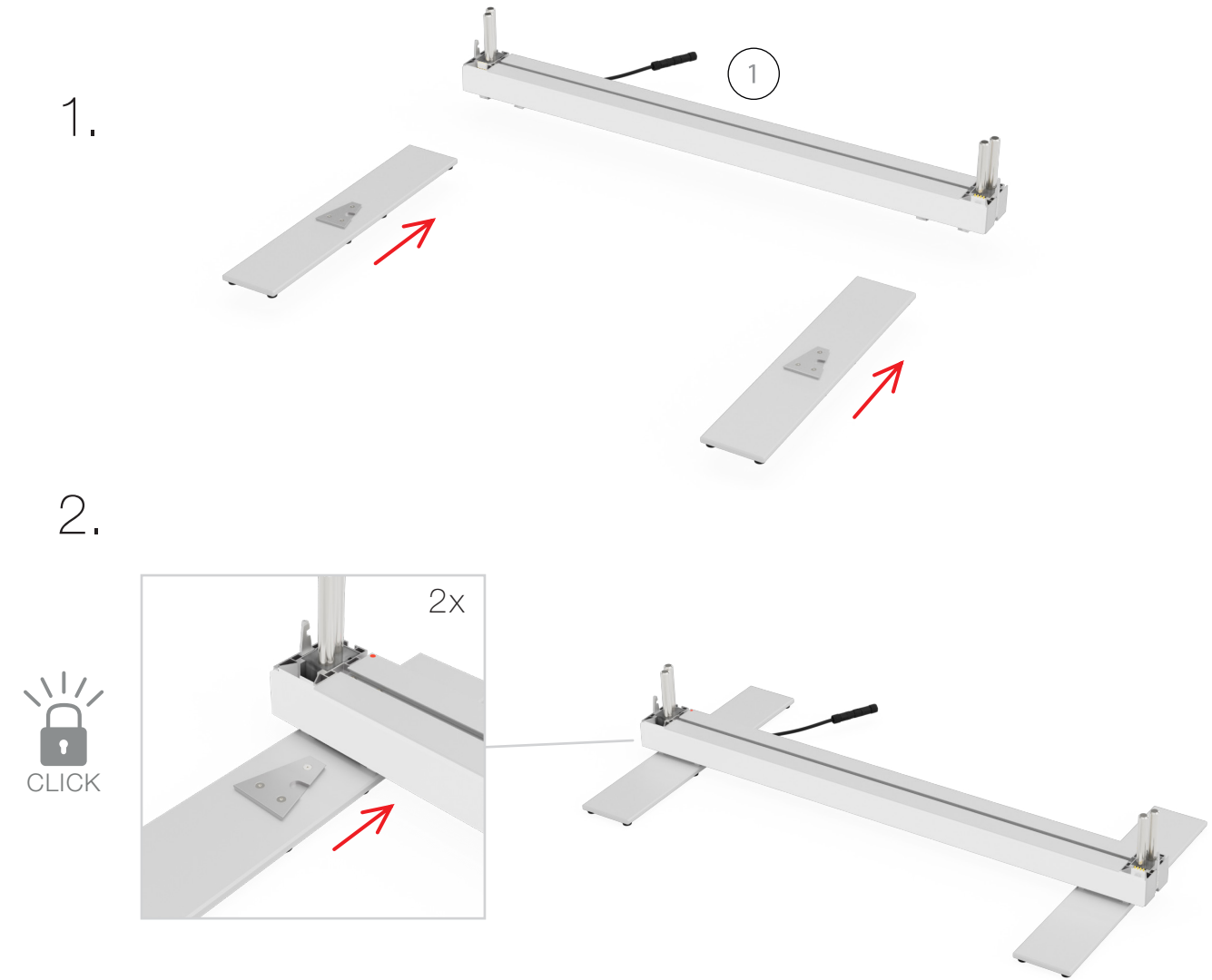



3.

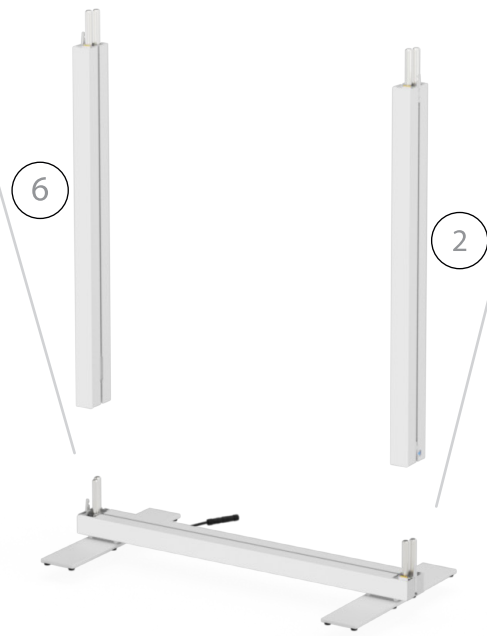
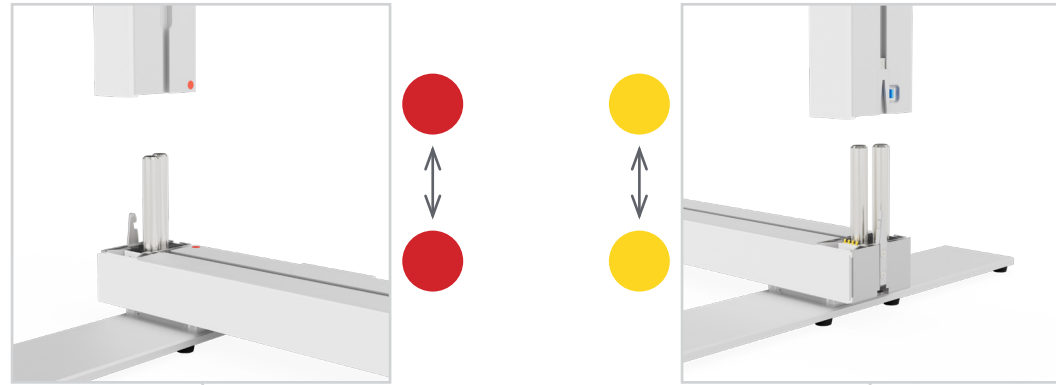

4.

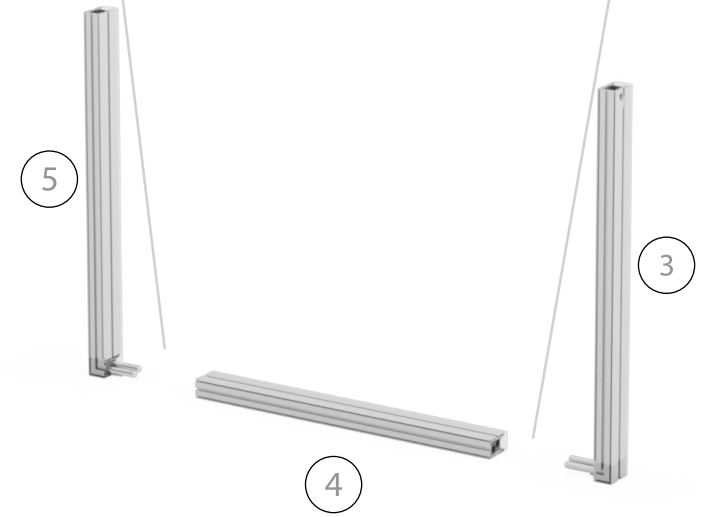
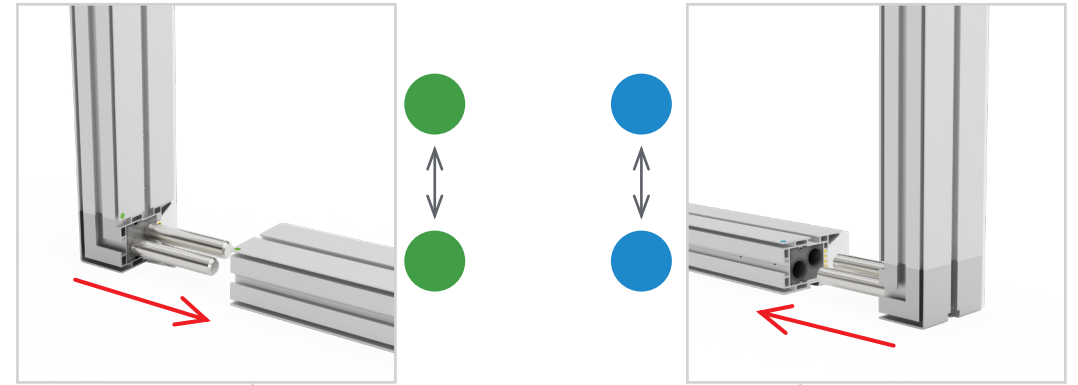



5.

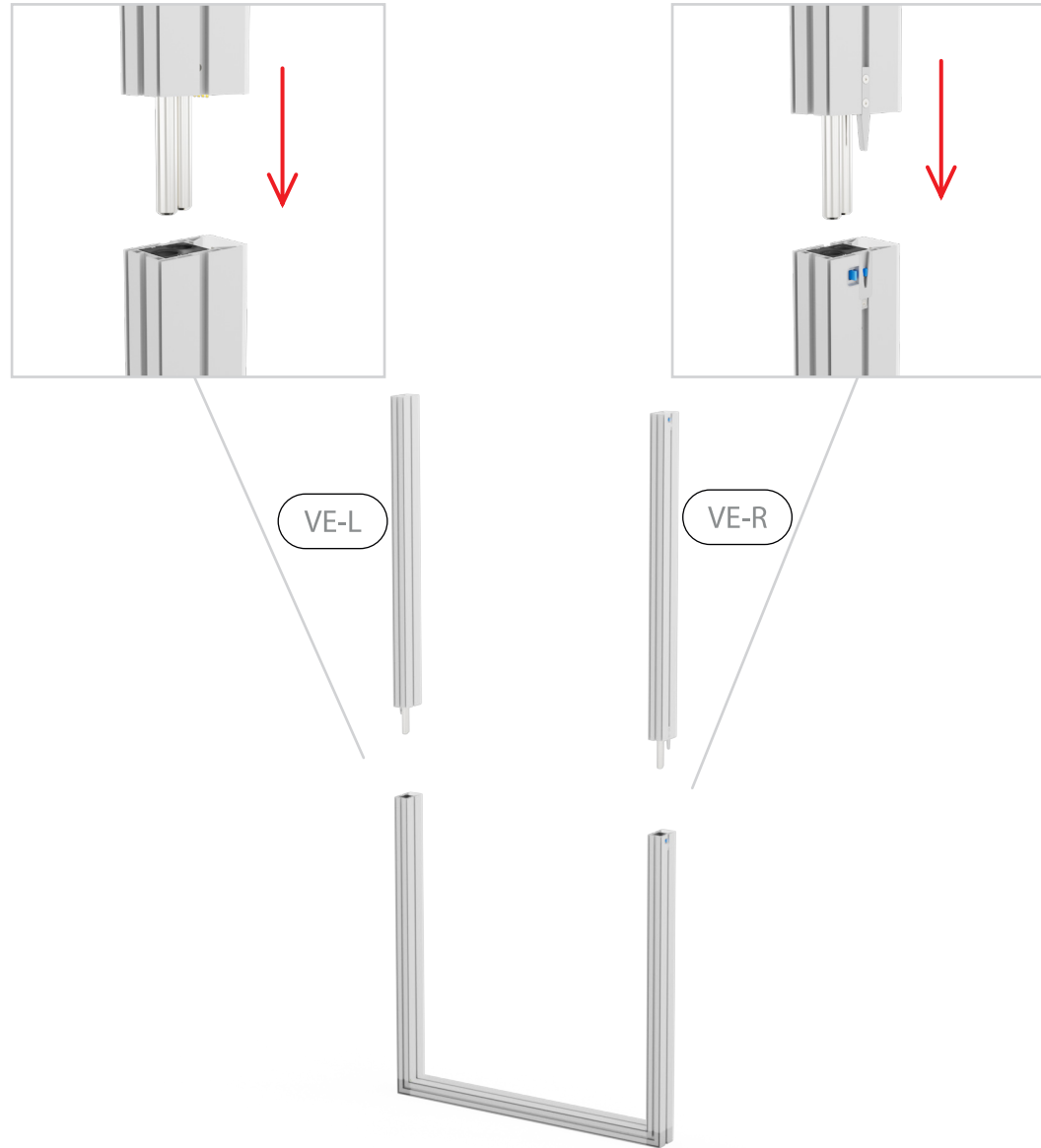

6.

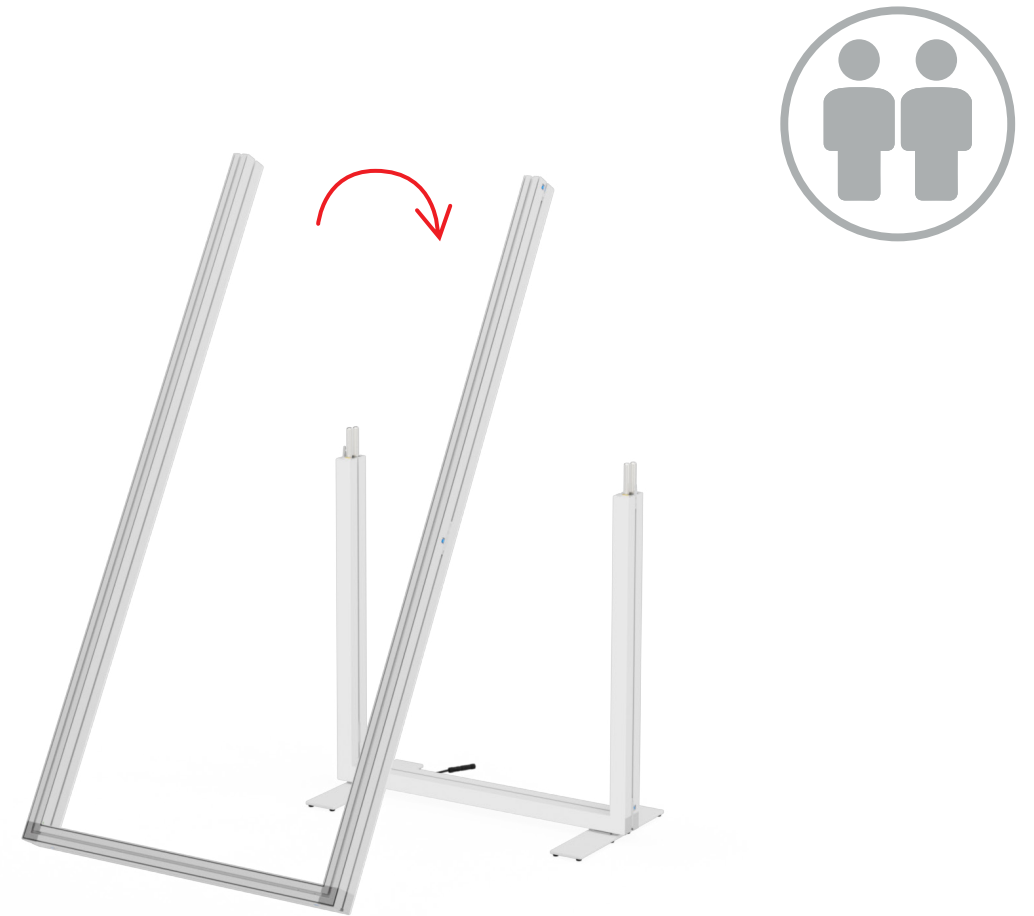



7.

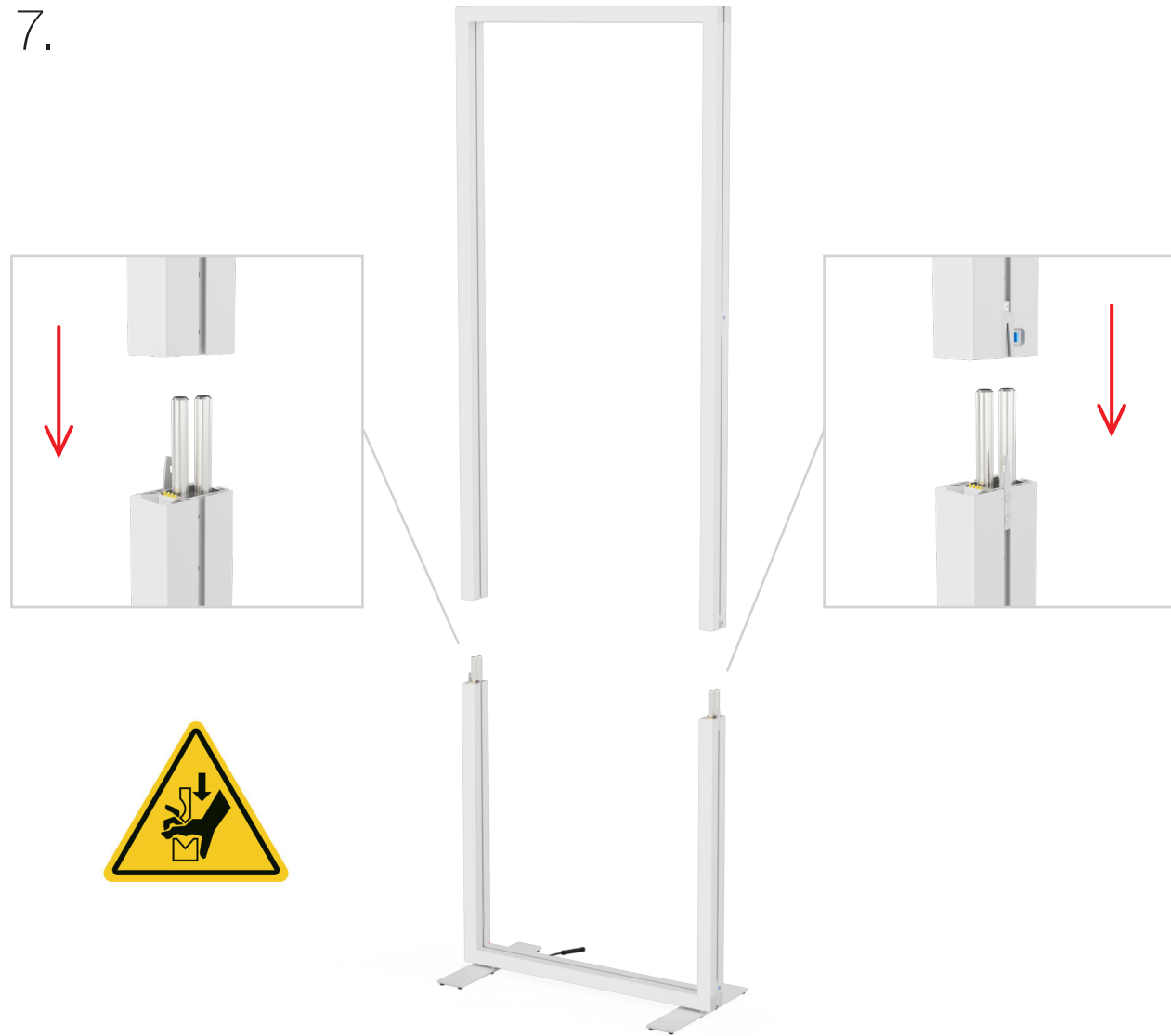

8.

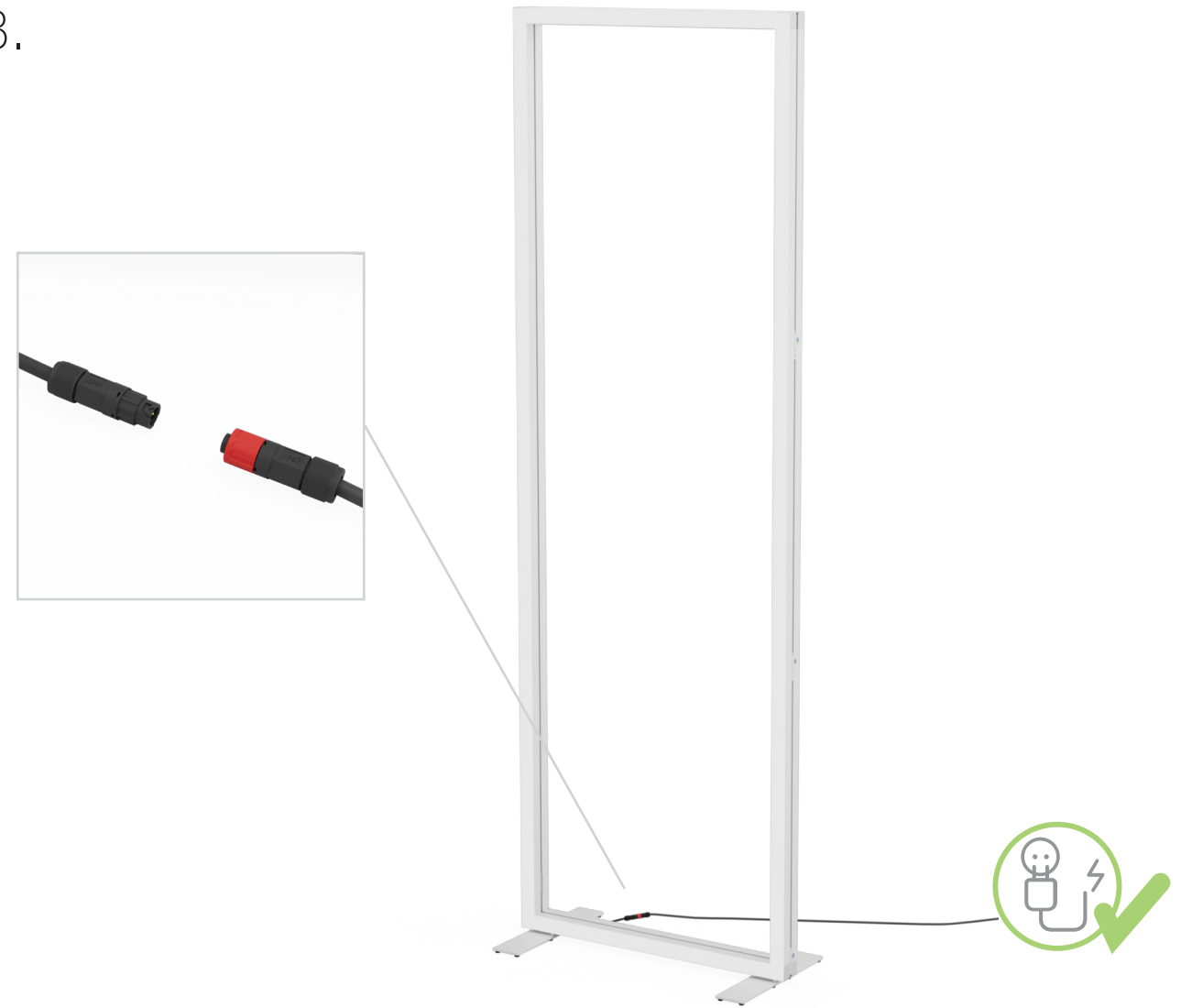

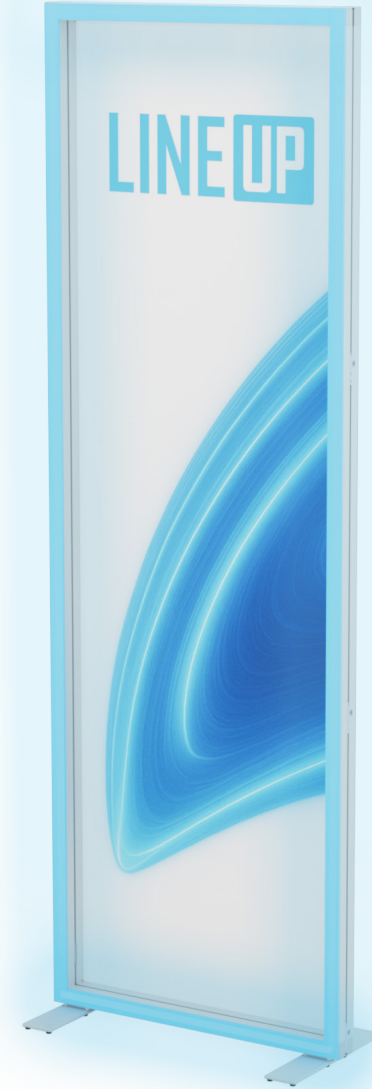
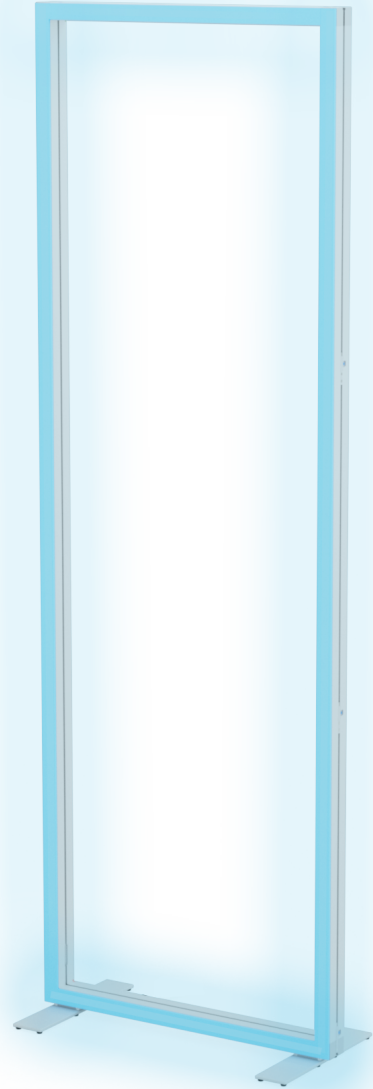

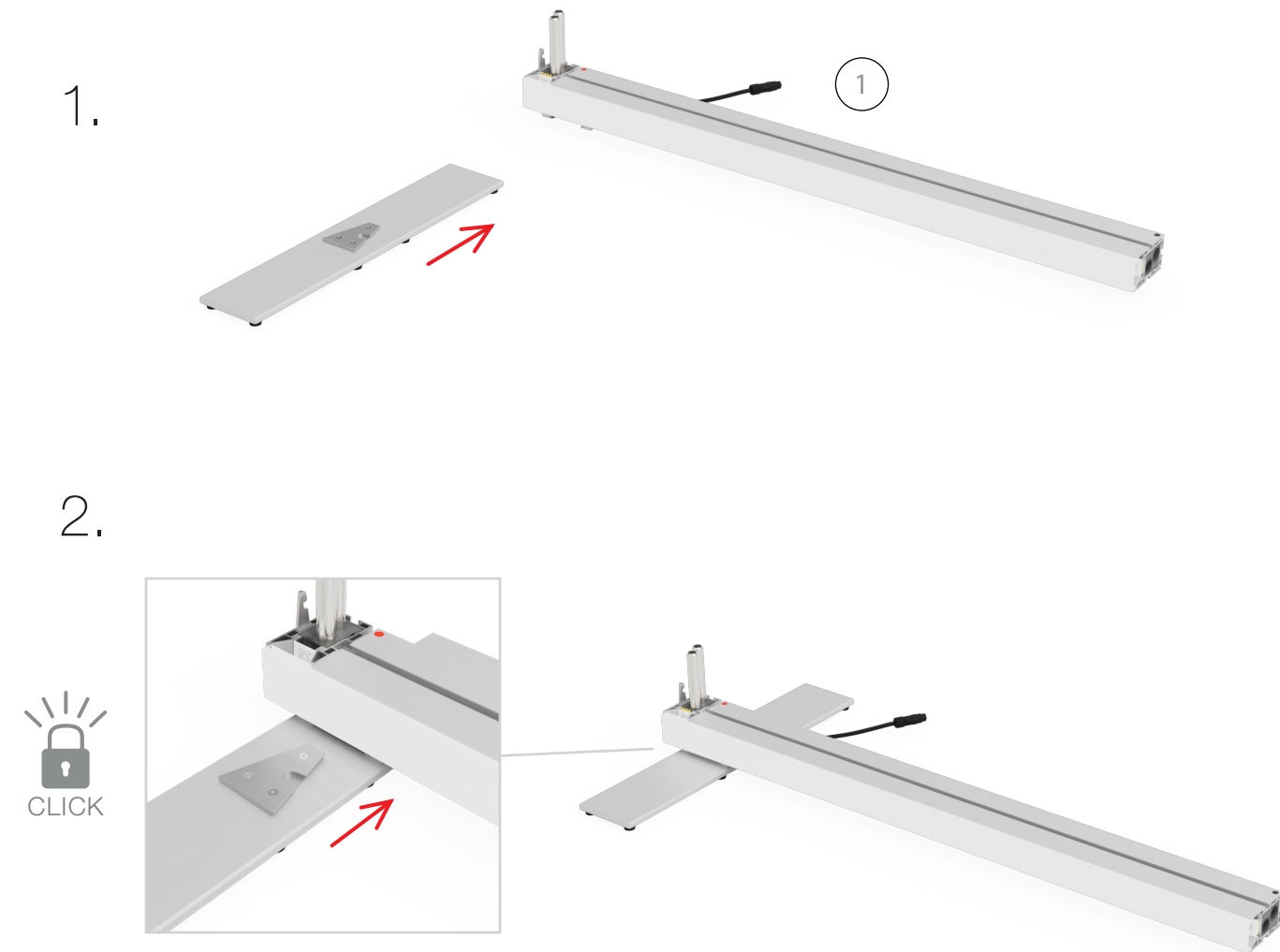
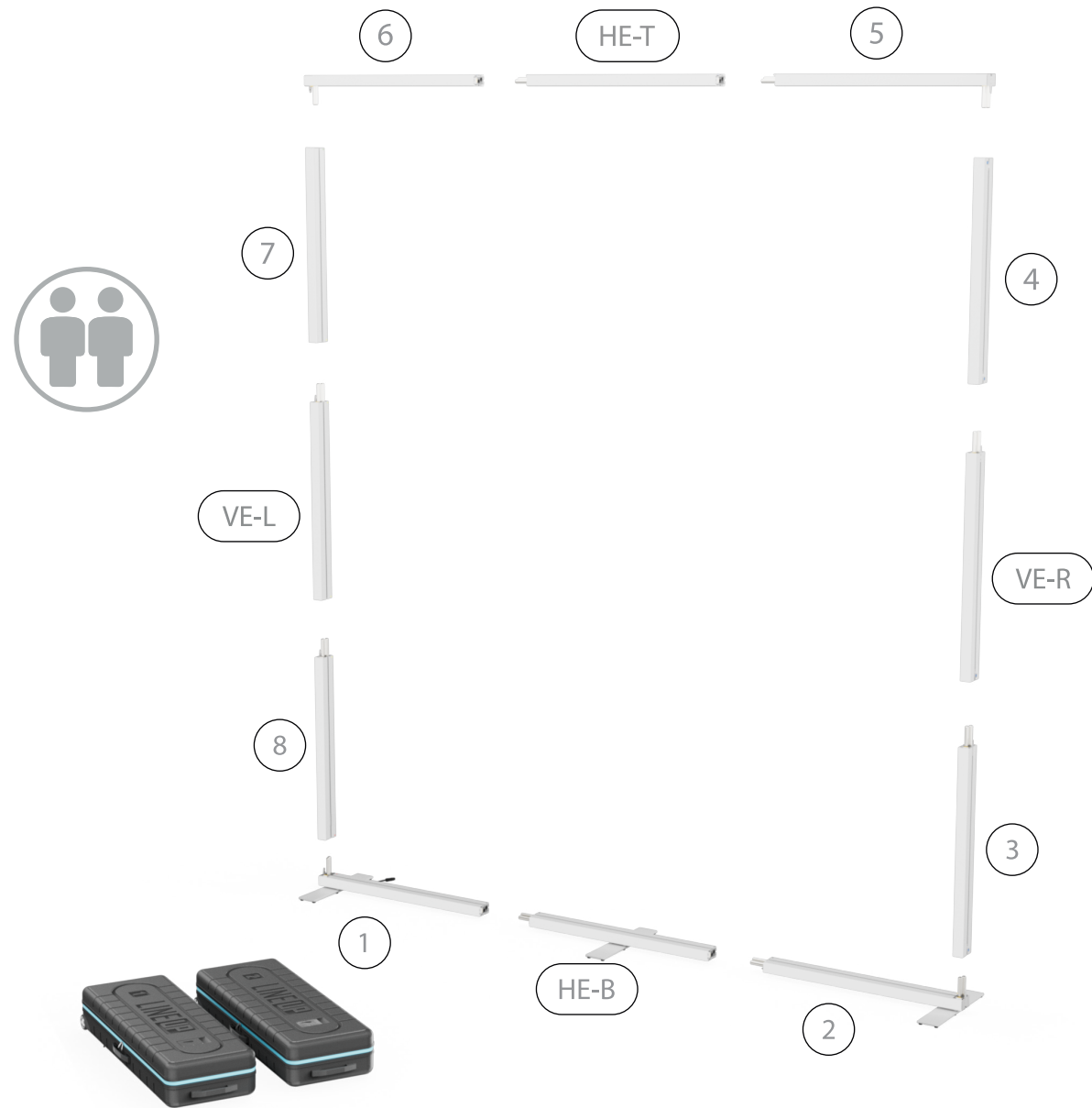



3.

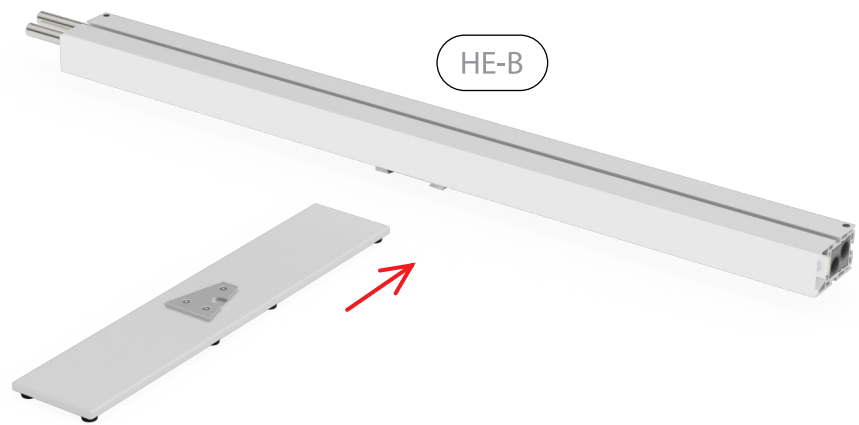

4.

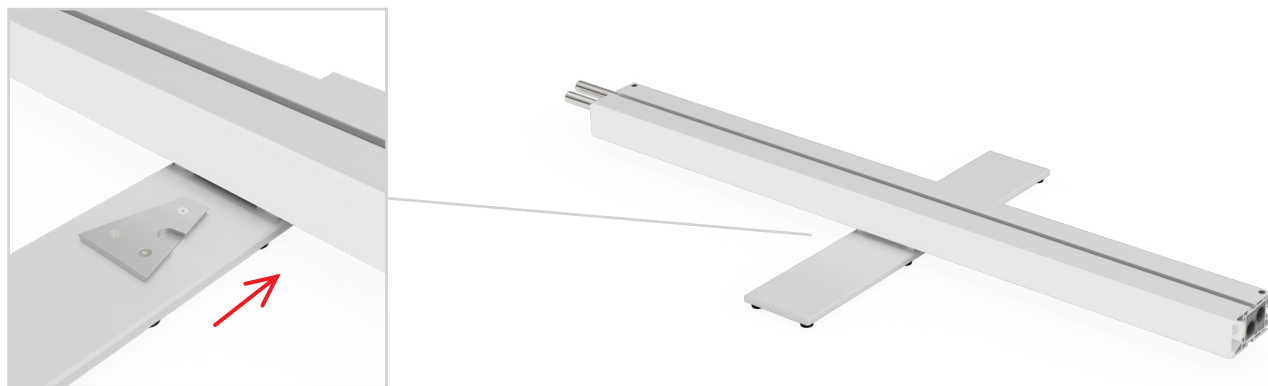

5.

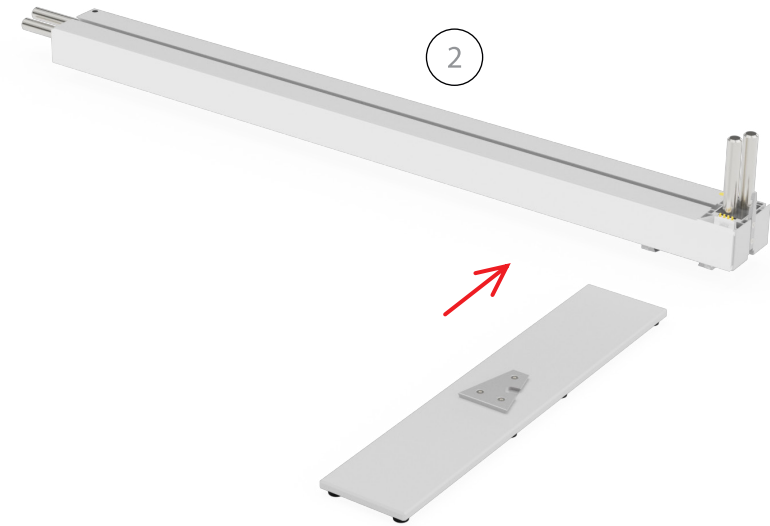

6.

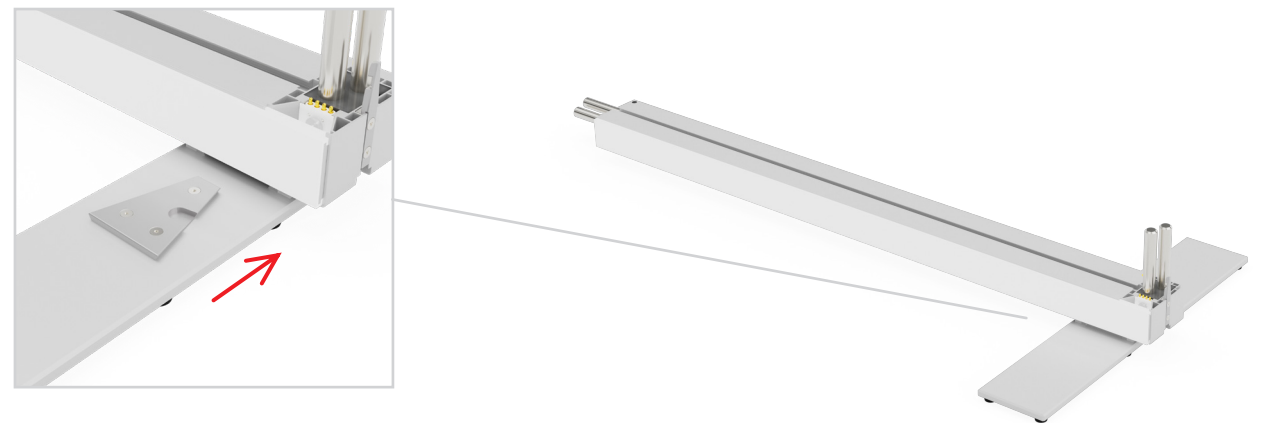

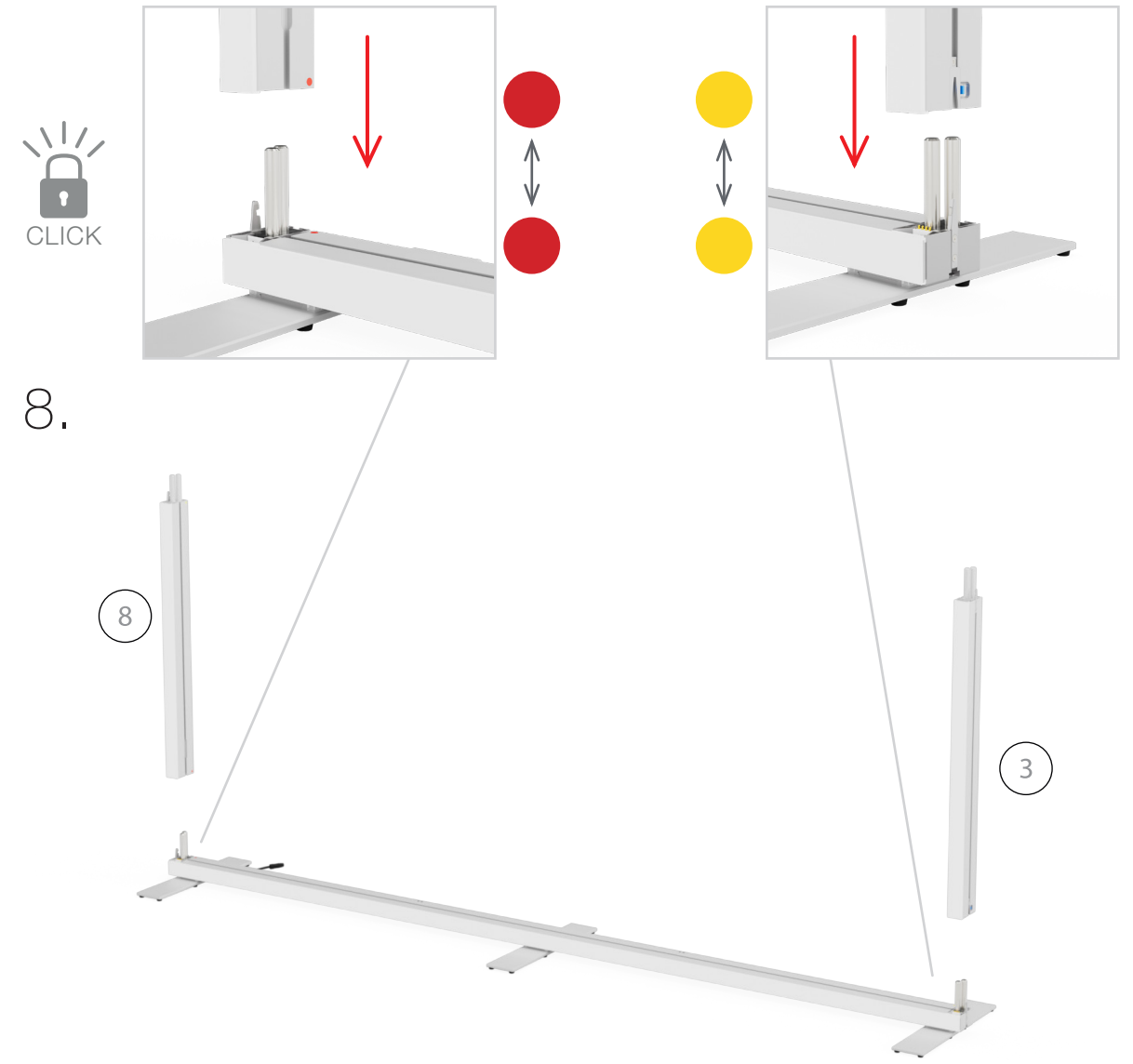
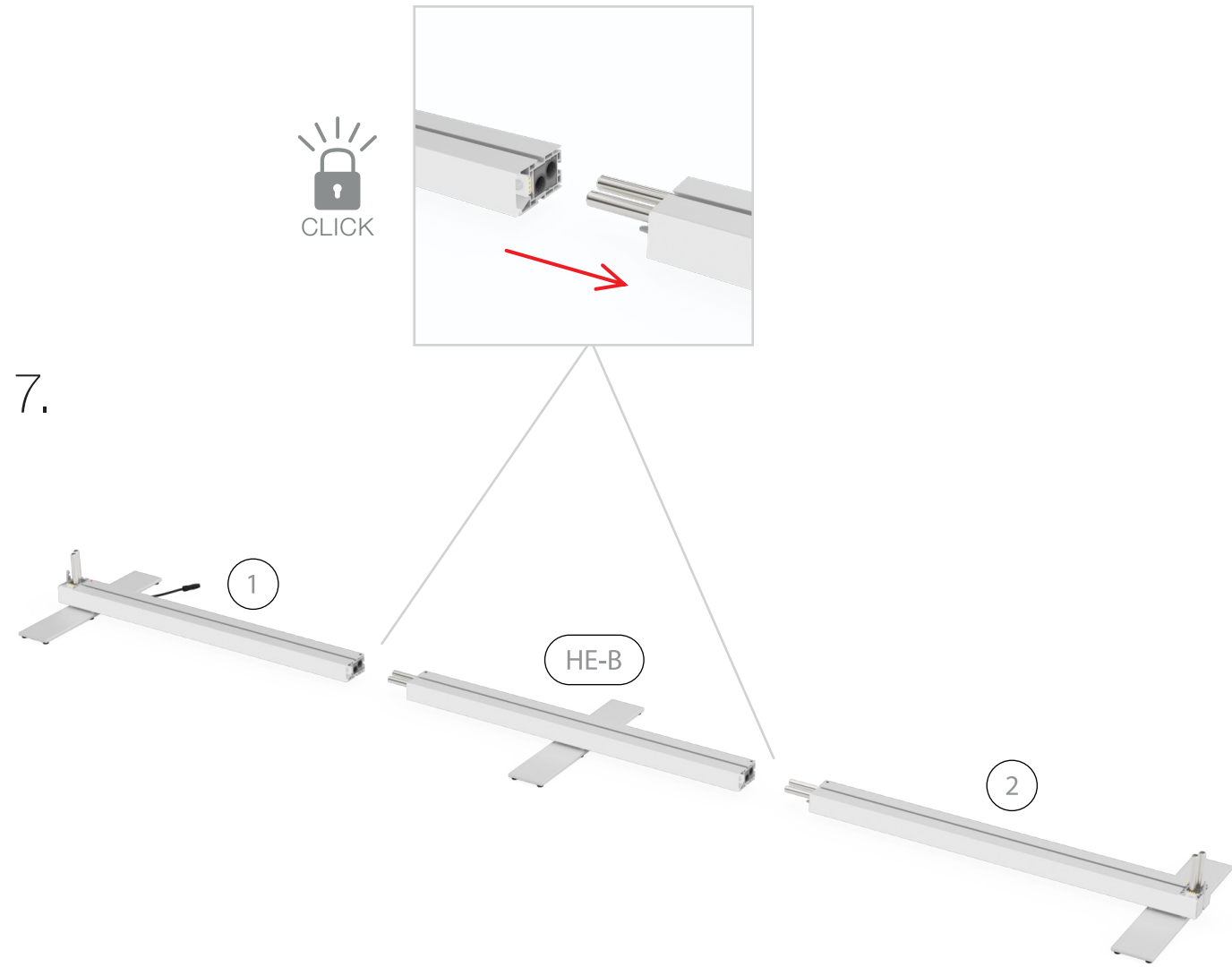
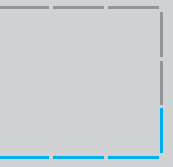
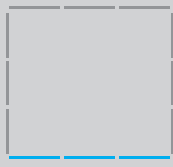

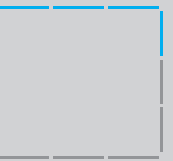

9.

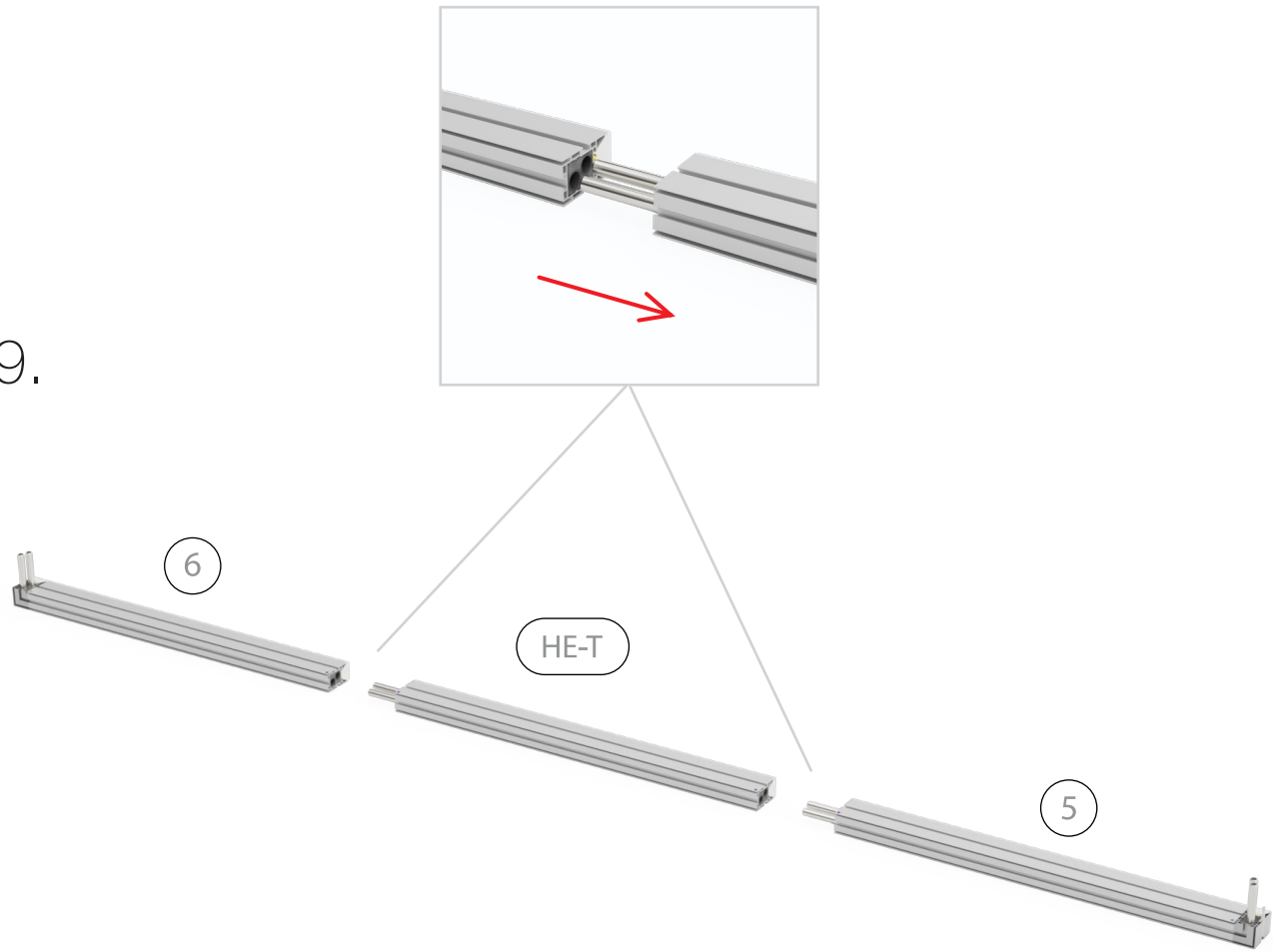

10.

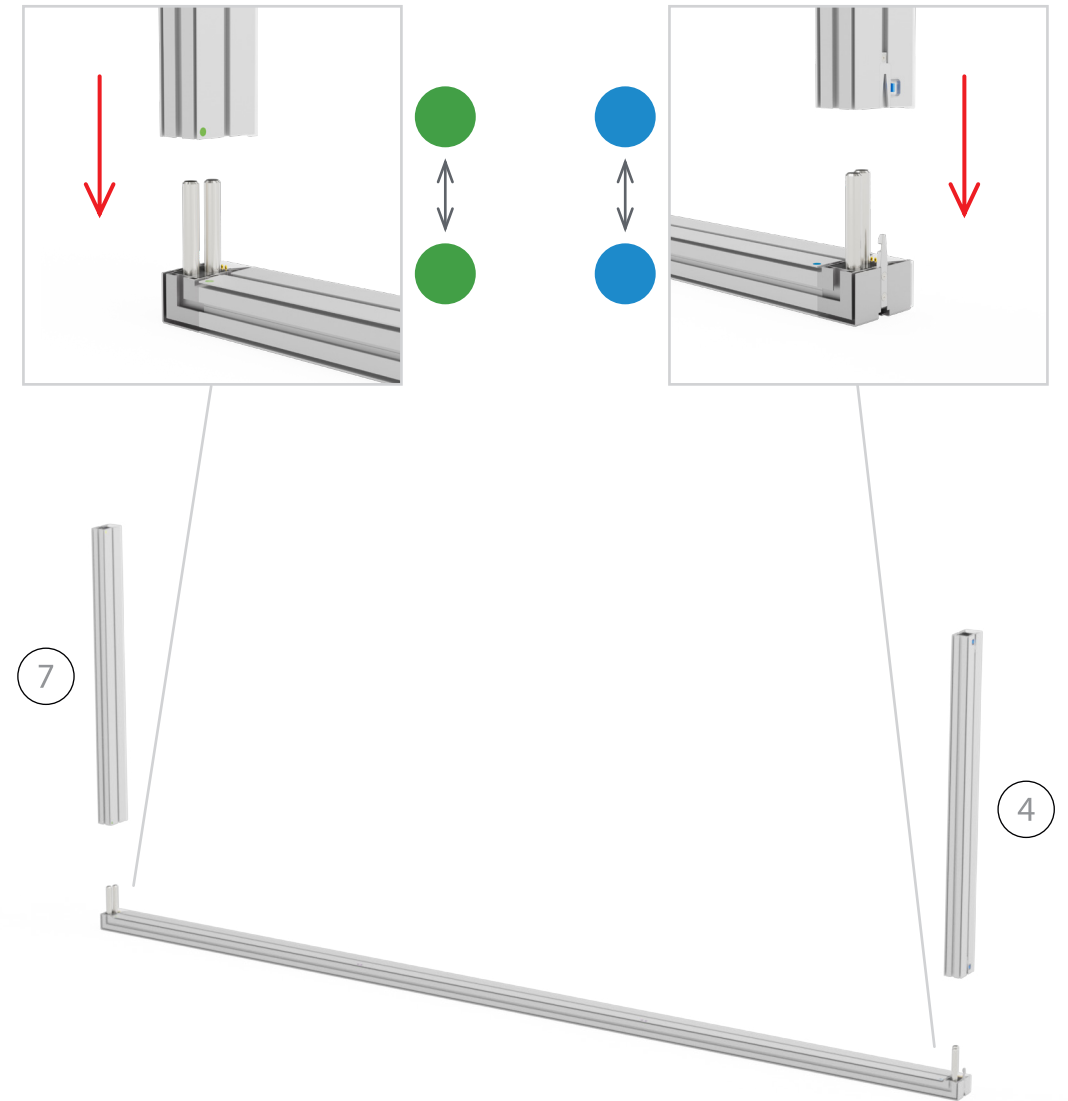

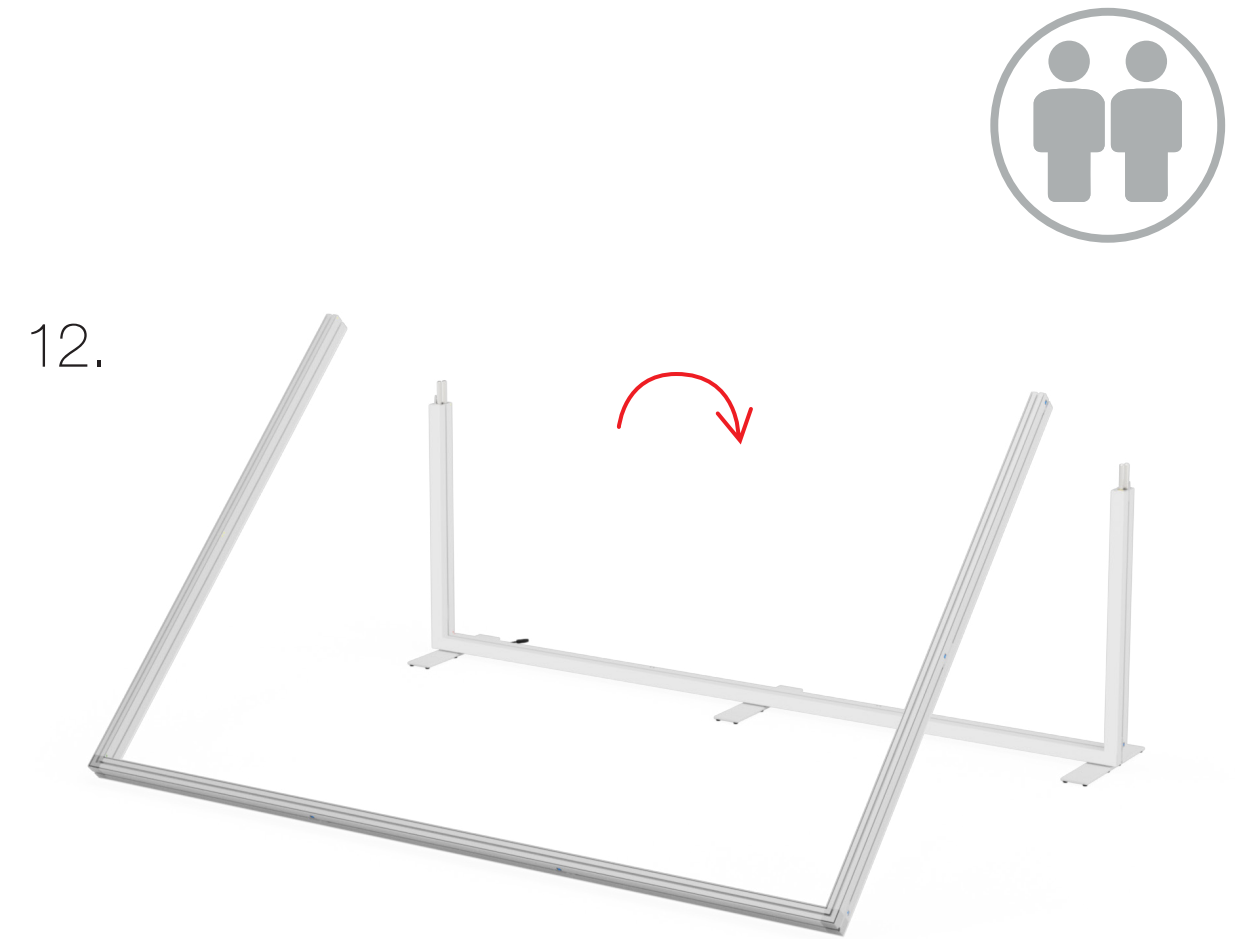
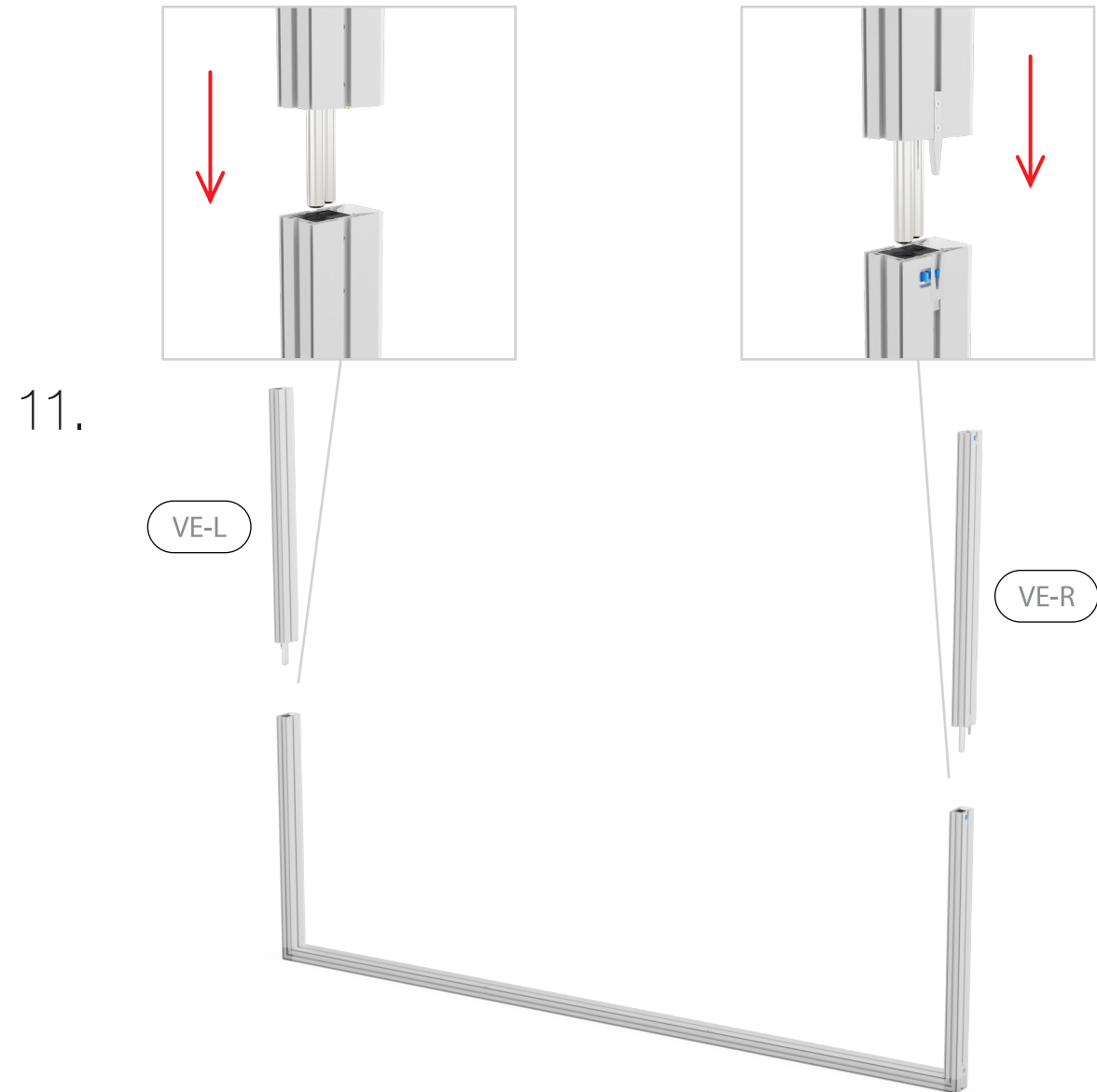
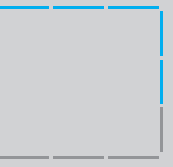
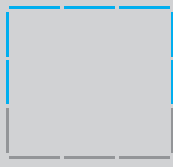

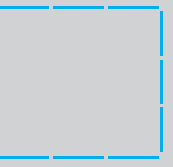
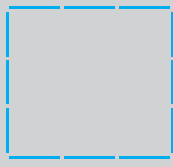

13.

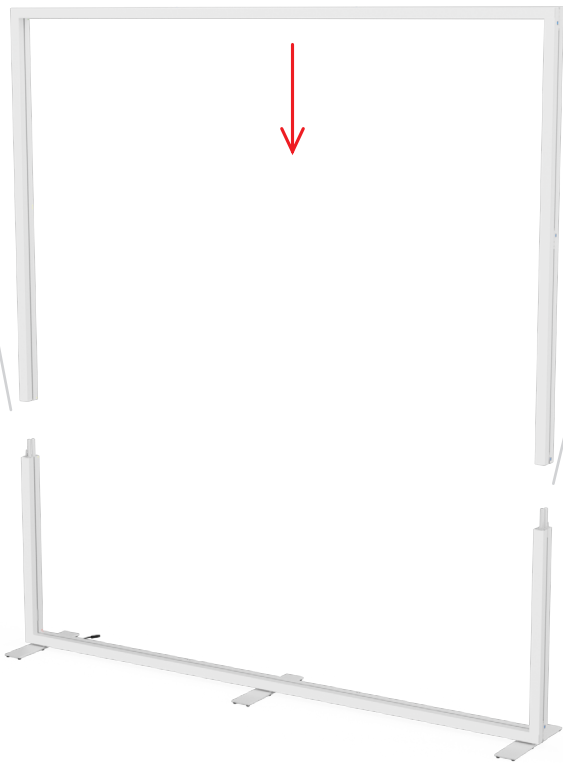
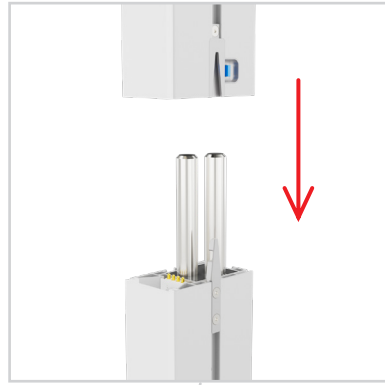
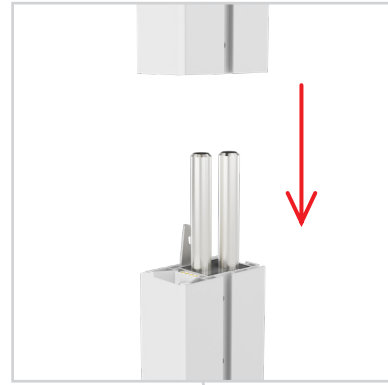

14.

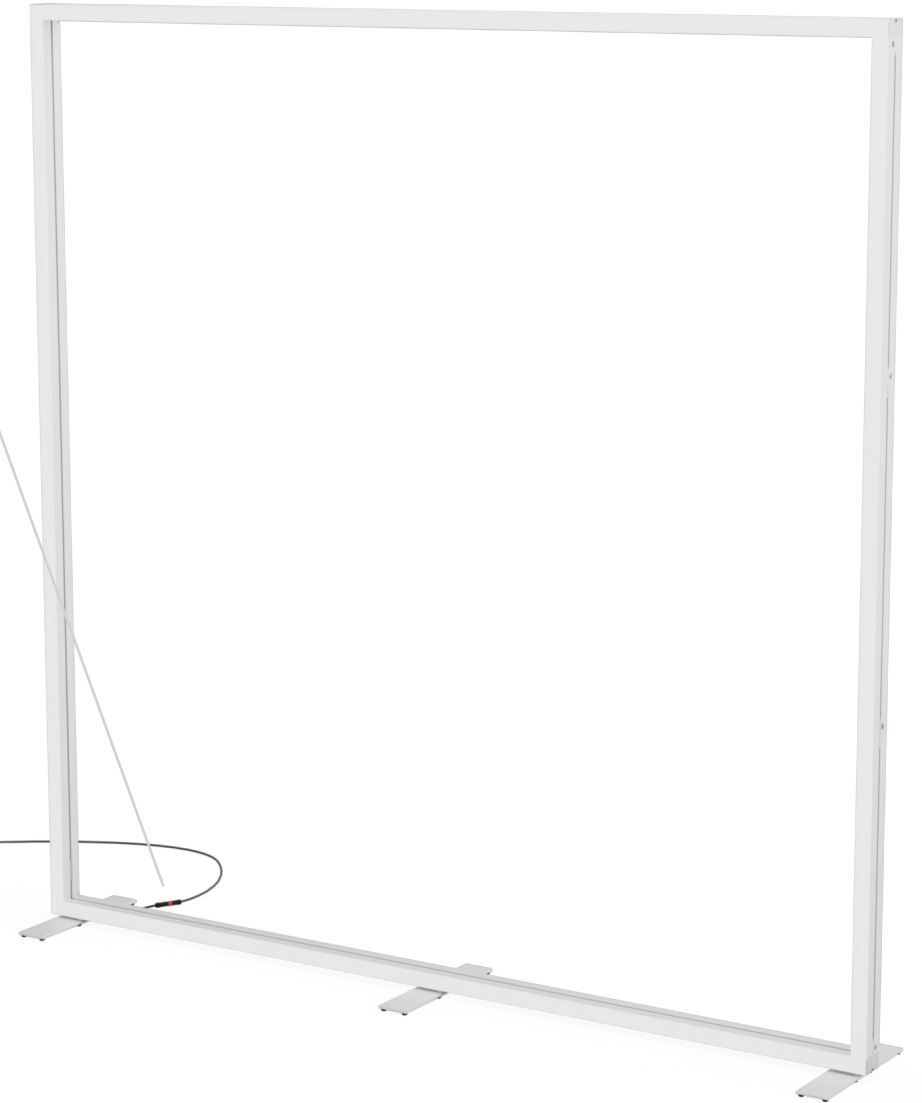
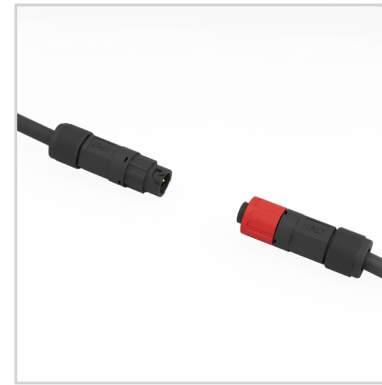

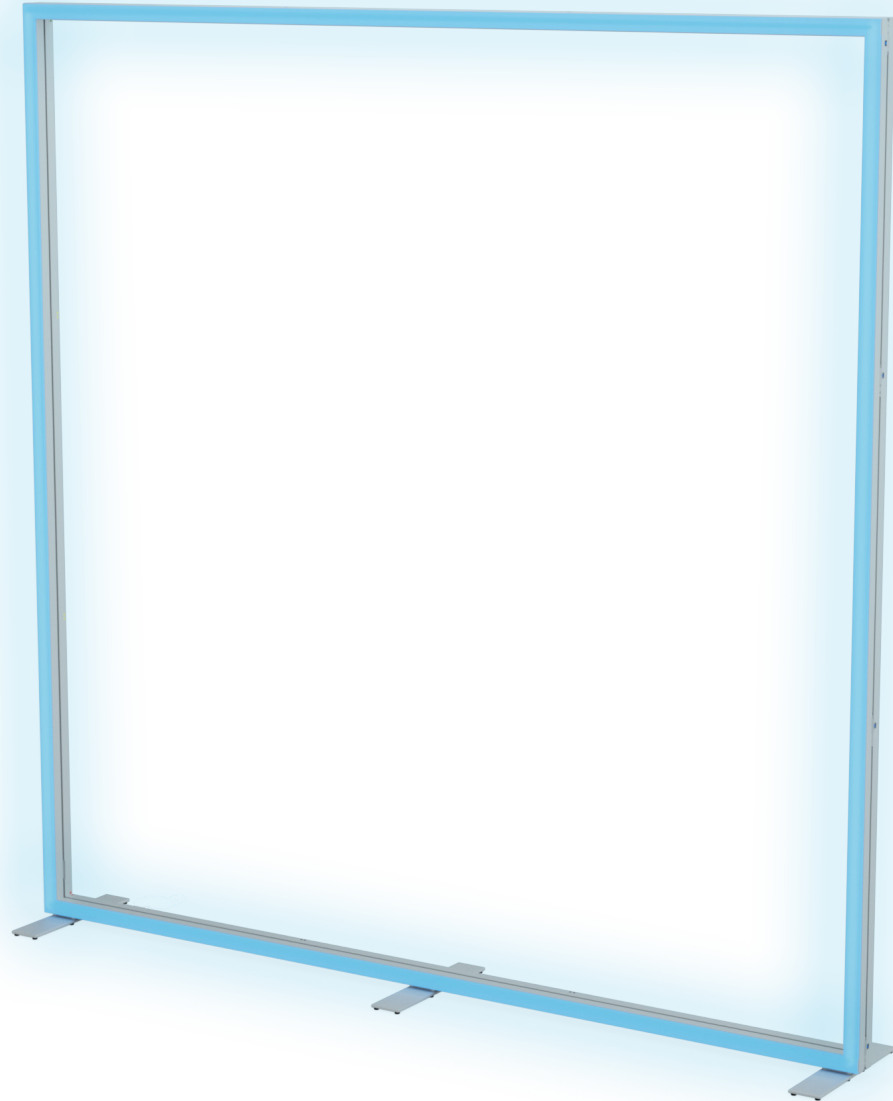
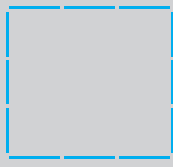

6-Zone RGB LINEUP Remote

This product uses the globally common 2.4 GHz frequency and GFSK control technology, offering low power consumption, long transmission distance, strong interference resistance, and fast communication. It controls LINEUP smart lighting for color, color temperature, saturation, and brightness adjustment.

Dieses Produkt nutzt die weltweit gängige 2,4-GHz-Frequenz und GFSK-Steuerung. Es bietet geringen Stromverbrauch, große Reichweite, starke Störsicherheit und schnelle Übertragung. Damit lässt sich die LINEUP Beleuchtung in Farbe, Farbtemperatur, Sättigung und Helligkeit steuern.

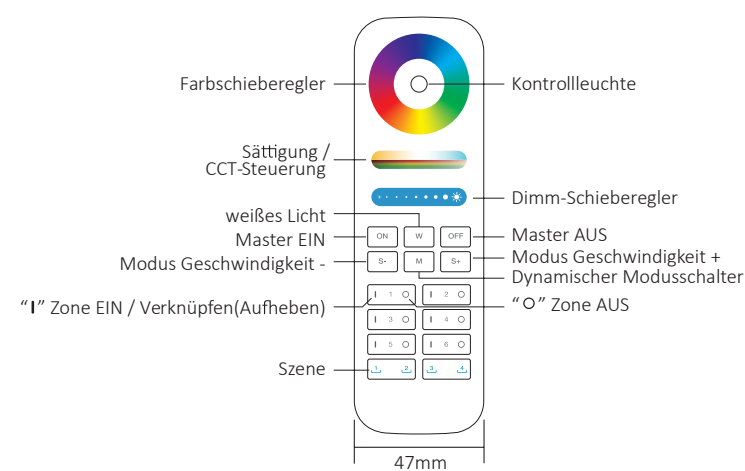
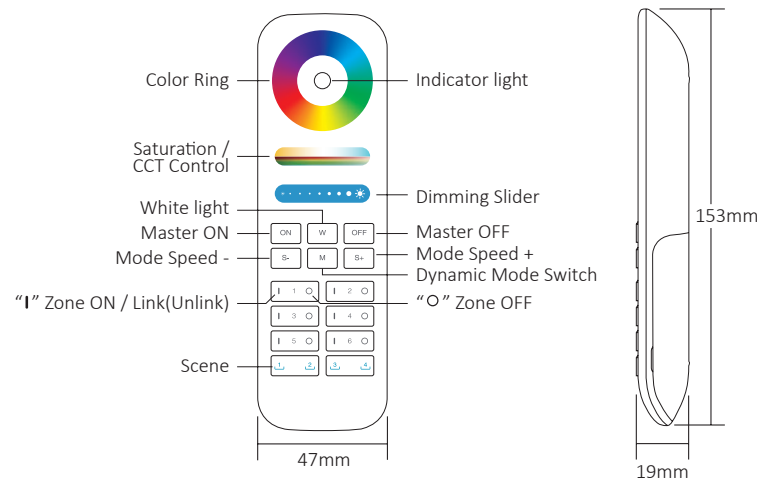

Touch the color ring to adjust light colors.
Berühren Sie den Farbring, um die Lichtfarben anzupassen.



Under white light mode, adjust light color temperature. Under color light mode, adjust color saturation.
Passen Sie im Weißlichtmodus die Farbtemperatur des Lichts an. Passen Sie im Farblichtmodus die Farbsättigung an.



Slide the brightness slider to adjust light the brightness.
Schieben Sie den Helligkeitsregler, um die Helligkeit anzupassen.



Short press switch to white light mode.
Kurz drücken, um in den Weißlichtmodus zu wechseln.



Short press: control all paired lights; Long press: dim top brightness for all lights.
Kurz drücken: Alle gekoppelten Lichter steuern; Langes Drücken: Dimmen Sie die obere Helligkeit für alle Lichter.



Short press: turn off all paired lights; Long press: turn on "night light mode" for all lights.
Kurz drücken: Alle gekoppelten Lichter ausschalten; Langes Drücken: Schalten Sie den „Nachtlichtmodus“ für alle Lichter ein.



Short press switch to Dynamic Mode.
Kurz drücken, um in den dynamischen Modus zu wechseln.



Under dynamic mode: Speed up dynamic mode while pressing shortly; Under static mode: 60s delay off while doing long press (countdown started once the light flashes one time).
Im dynamischen Modus: Beschleunigen Sie den dynamischen Modus, indem Sie kurz drücken; Im statischen Modus: 60 Sekunden Verzögerung beim langen Drücken (Countdown gestartet, sobald das Licht einmal blinkt).



Under dynamic mode : slow down speed of dynamic mode once press shortly; Under static mode: 30s delay off while doing long press (countdown started once the light flashes one time).
Im dynamischen Modus: Geschwindigkeit des dynamischen Modus verlangsamen, einmal kurz drücken; Im statischen Modus: 30 Sekunden Verzögerung beim langen Drücken (Countdown gestartet, sobald das Licht einmal blinkt).



Under dynamic mode : slow down speed of dynamic mode once press shortly; Under static mode: 30s delay off while doing long press (countdown started once the light flashes one time).
Kurzdruck: Szene aktivieren Langdruck 3 Sekunden: Farb- oder Dynamikmodus speichern (Das Licht blinkt einmal langsam, sobald es erfolgreich abgeschlossen wurde).

6-Zone RGB LINEUP Remote

Linking Code Instructions

Anleitung zum Verknüpfen der Fernbedienung



1

Disconnect the LINEUP frame from the power supply for 10 seconds, then reconnect it.

Stromversorgung des LINEUP-Rahmens für 10 Sekunden unterbrechen und wiederherstellen.

2

Short press "1" button 3 times within 3 seconds when light on.

Drücken Sie die Taste "1" 3 mal innerhalb von 3 Sekunden, wenn das Licht an ist.

3

Lights blink 3 times slowly means linking is done successfully.

Die Beleuchtung blinkt 3 mal langsam, dass bedeutet die Verknüpfung wurde erfolgreich durchgeführt.



Linking failed if light is not blinking slowly, Please follow above steps again. (Note: Light that have linked can't link again)

Die Verknüpfung ist fehlgeschlagen, wenn das Licht nicht langsam blinkt. Bitte befolgen Sie die obigen Schritte erneut. (Hinweis: Licht, welches verknüpft ist, kann nicht erneut verknüpft werden)

Unlinking Code Instructions

Anleitung zum Aufheben der Verknüpfung der Fernbedienung



1

Disconnect the LINEUP frame from the power supply for 10 seconds, then reconnect it.

Stromversorgung des LINEUP-Rahmens für 10 Sekunden unterbrechen und wiederherstellen.

2

Short press "1" button 5 times within 3 seconds when light on.

Drücken Sie die Taste "1" 5 mal innerhalb von 3 Sekunden, wenn das Licht an ist.

3

Lights blink 10 times quickly means unlinking is done successfully.

Die Beleuchtung blinkt 10 mal schnell, dass bedeutet die Verknüpfung wurde erfolgreich aufgehoben.



Unlinking failed if light is not blinking quickly, Please follow above steps again. (Note: Light haven't linked that don't need to unlink)

Das Aufheben der Verknüpfung ist fehlgeschlagen, wenn das Licht nicht schnell blinkt. Bitte befolgen Sie die obigen Schritte erneut. (Hinweis: Licht, welches nicht verknüpft wurde, muss nicht getrennt werden)

6-Zone RGB LINEUP Remote

Group control instruction/ Gruppensteuerungsanweisung

Pairing lights into different groups, dim and control light flexibly Group control solution: Press "1" firstly and dim, example as below.
Attention:

1. Countless lights can be added into each zone.
2. One light only can be paired with one sub zone from anyone remote.

Lampen in verschiedene Gruppen koppeln, Licht flexibel dimmen und steuern Gruppensteuerungslösung: Drücken Sie zuerst "1" und dimmen Sie, Beispiel wie unten.

Achtung:

1. *Jeder Zone können unzählige Lichter hinzugefügt werden.*
2. *Ein Gerät kann nur mit einer der Gruppen derselben Fernbedienung gekoppelt werden.*

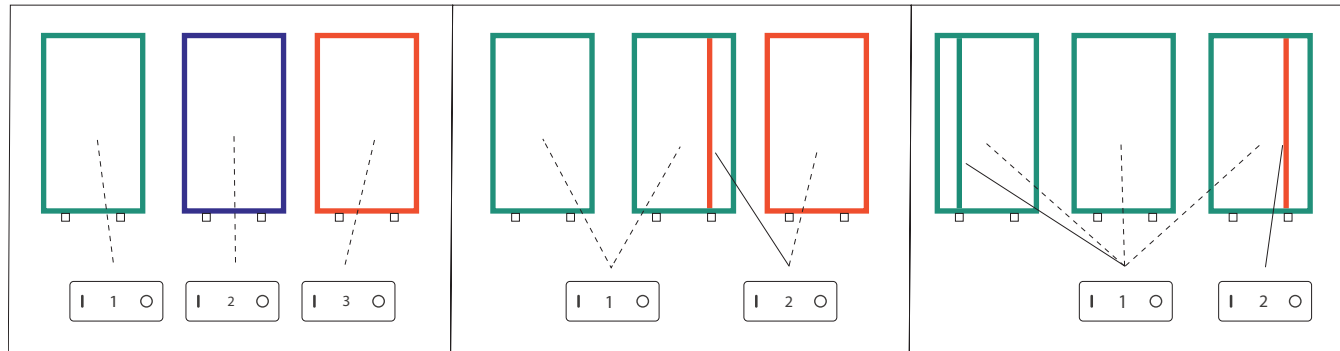

Attention:

1. This remote control only supports LINEUP products. Please check the product information to confirm compatibility.
2. If the indicator light on the remote blinks rapidly during use, please replace the battery in time. Only use high-quality batteries to avoid damage caused by leaking battery fluid.
3. The remote is a precision electronic device. Do not use it in humid or high-temperature environments. Remove the battery when not in use and store the remote in a dry, static-free place.
4. Do not use the remote in areas with large metal surfaces or strong electromagnetic interference, as this can affect the control range and performance.

Achtung:

1. *Diese Fernbedienung ist ausschließlich für LINEUP Produkte geeignet. Bitte prüfen Sie vorab die Produktinformationen zur Kompatibilität.*
2. *Wenn die Anzeigeleuchte an der Fernbedienung schnell blinkt, wechseln Sie bitte rechtzeitig die Batterie. Verwenden Sie nur hochwertige Batterien, um Schäden durch auslaufende Batterien zu vermeiden.*
3. *Die Fernbedienung ist ein präzises Elektronikprodukt. Verwenden Sie sie nicht in feuchter oder sehr heißer Umgebung. Nehmen Sie die Batterie bei Nichtgebrauch heraus und lagern Sie die Fernbedienung trocken und vor statischer Elektrizität geschützt.*
4. *Vermeiden Sie die Nutzung in Bereichen mit großen Metallflächen oder starker elektromagnetischer Strahlung, da dies die Reichweite und Funktion der Fernbedienung beeinträchtigen kann.*

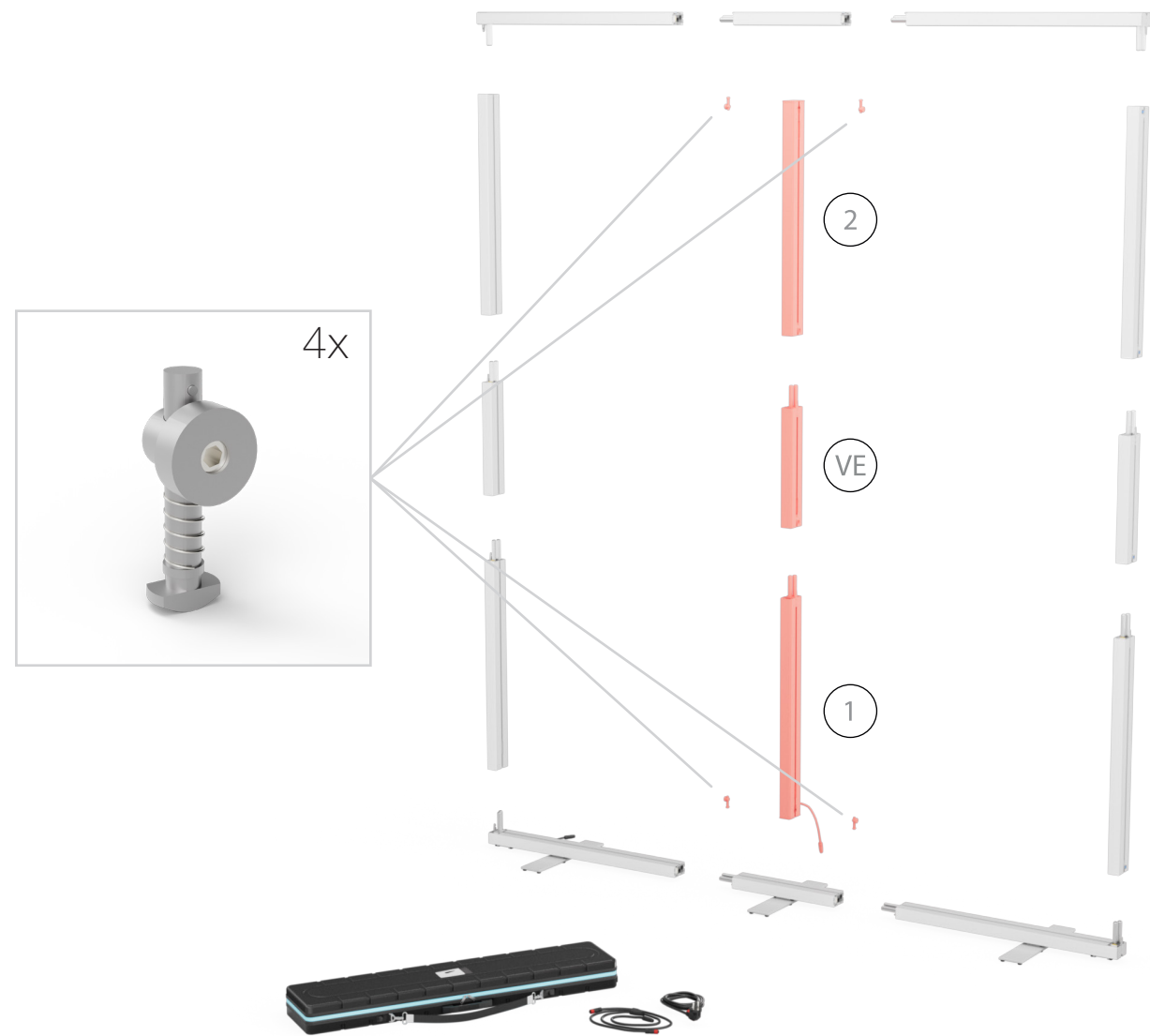

1.

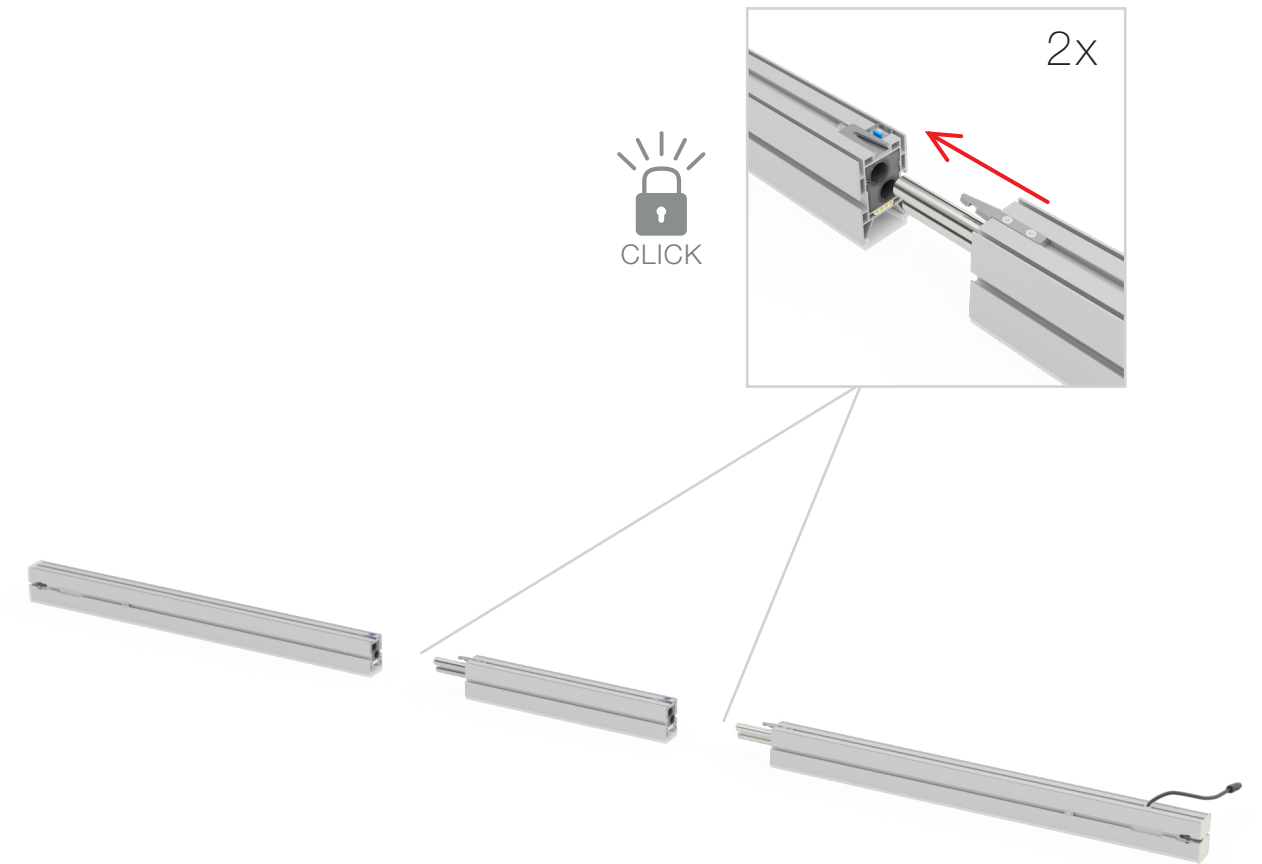

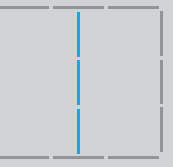
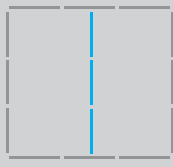

2.

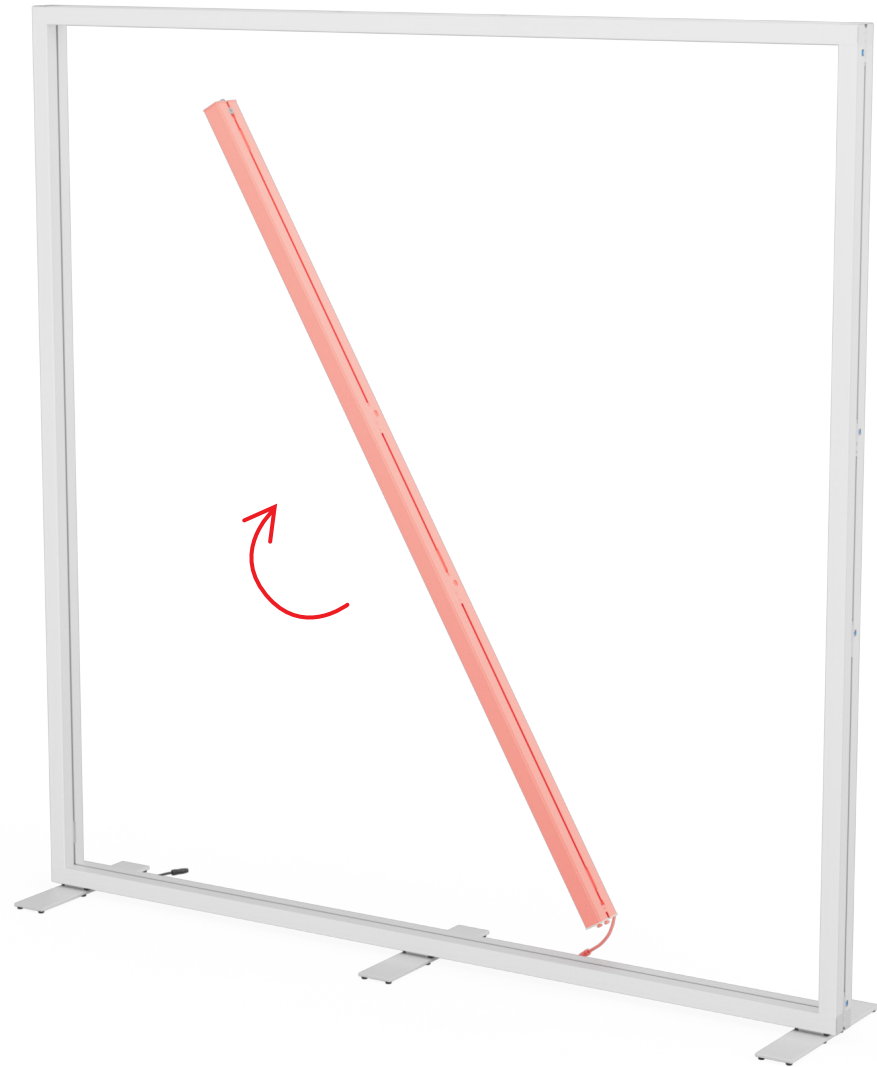

3.

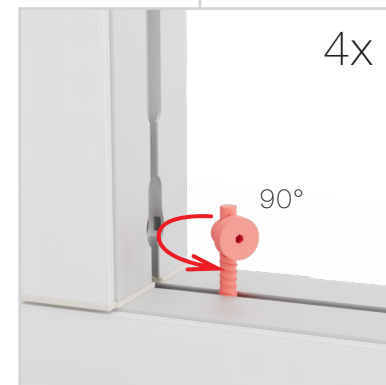
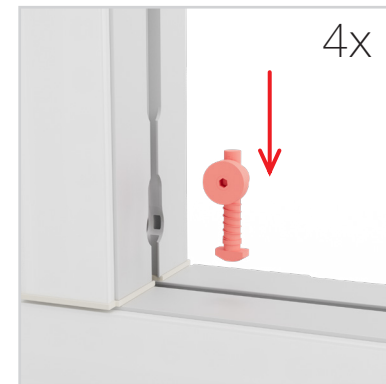

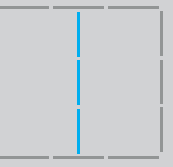
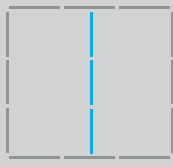

4.

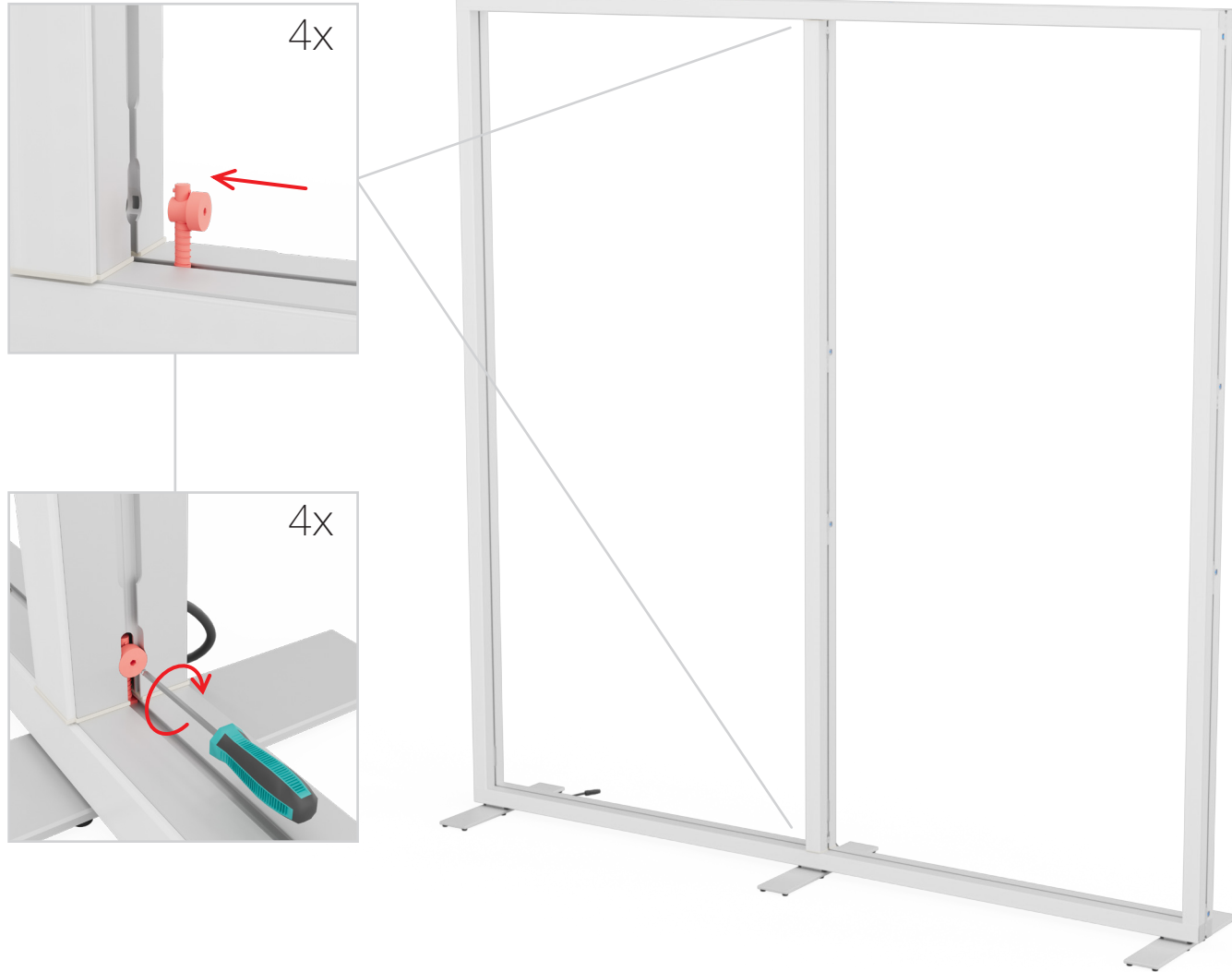

5.

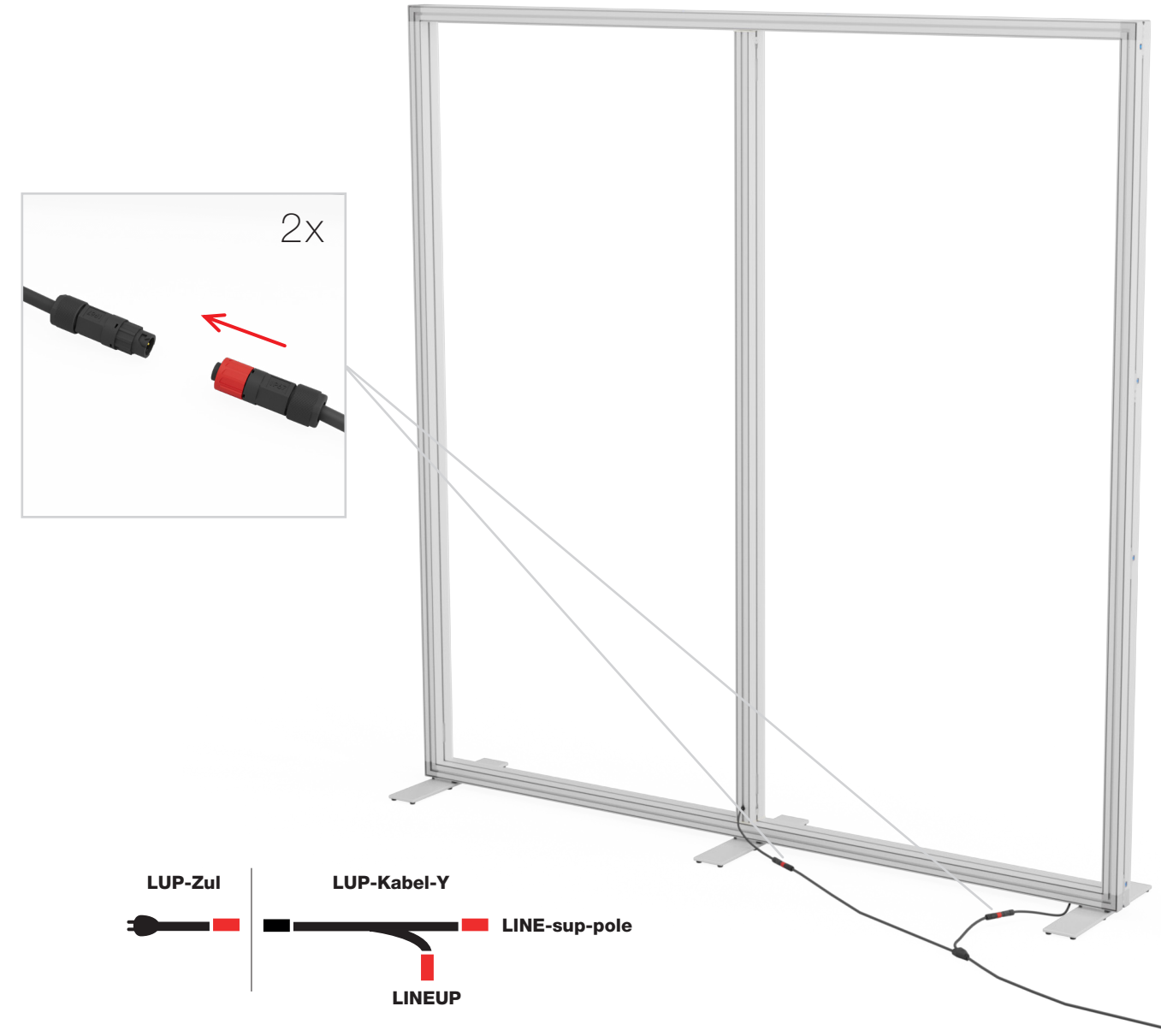

6-Zone RGB LINEUP Remote

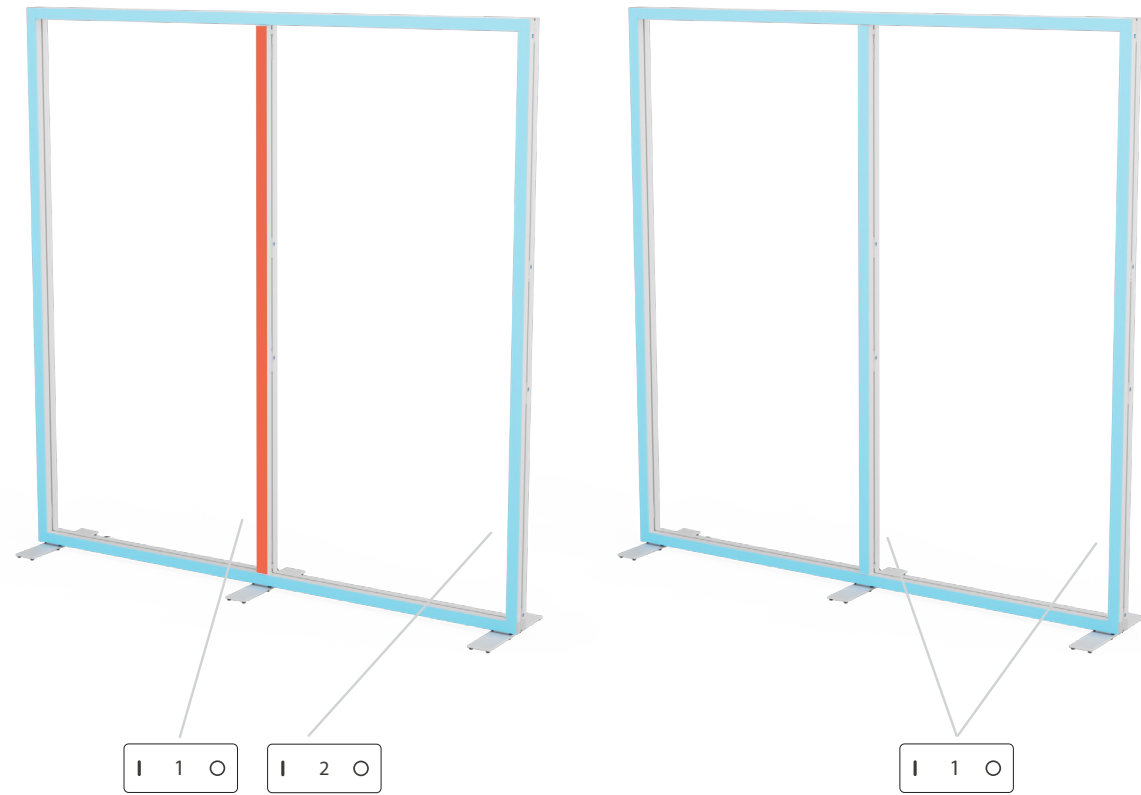

Two groups usage
sup-pole and LINEUP-xxx-xxx, two colors.
*Zwei Gruppen Verwendung
sup-pole und LINEUP-xxx-xxx zwei Farben.*

One group usage
sup-pole and LINEUP-xxx-xxx, one color.
*Ein Gruppen Verwendung
sup-pole und LINEUP-xxx-xxx eine Farben.*



page 30
siehe Seite 30

Linking Code Instructions

Anleitung zum Verknüpfen der Fernbedienung



1

Disconnect the LINEUP frame from the power supply for 10 seconds, then reconnect it.

*Stromversorgung des
LINEUP-Rahmens für 10
Sekunden unterbrechen und
wiederherstellen.*

2

Short press "1" button 3 times within 3 seconds when light on.

*Drücken Sie die Taste "1" 3
mal innerhalb von 3 Sekunden,
wenn das Licht an ist.*

3

Lights blink 3 times slowly means linking is done successfully.

*Die Beleuchtung blinkt 3 mal
langsam, dass bedeutet die
Verknüpfung wurde
erfolgreich durchgeführt.*



Linking failed if light is not blinking slowly, Please follow above steps again.
(Note: Light that have linked can't link again)

*Die Verknüpfung ist fehlgeschlagen, wenn das Licht nicht langsam blinkt.
Bitte befolgen Sie die obigen Schritte erneut.
(Hinweis: Licht, welches verknüpft ist, kann nicht erneut verknüpft werden)*

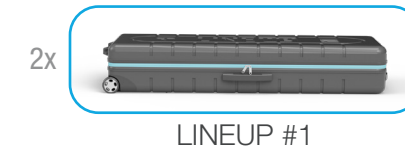
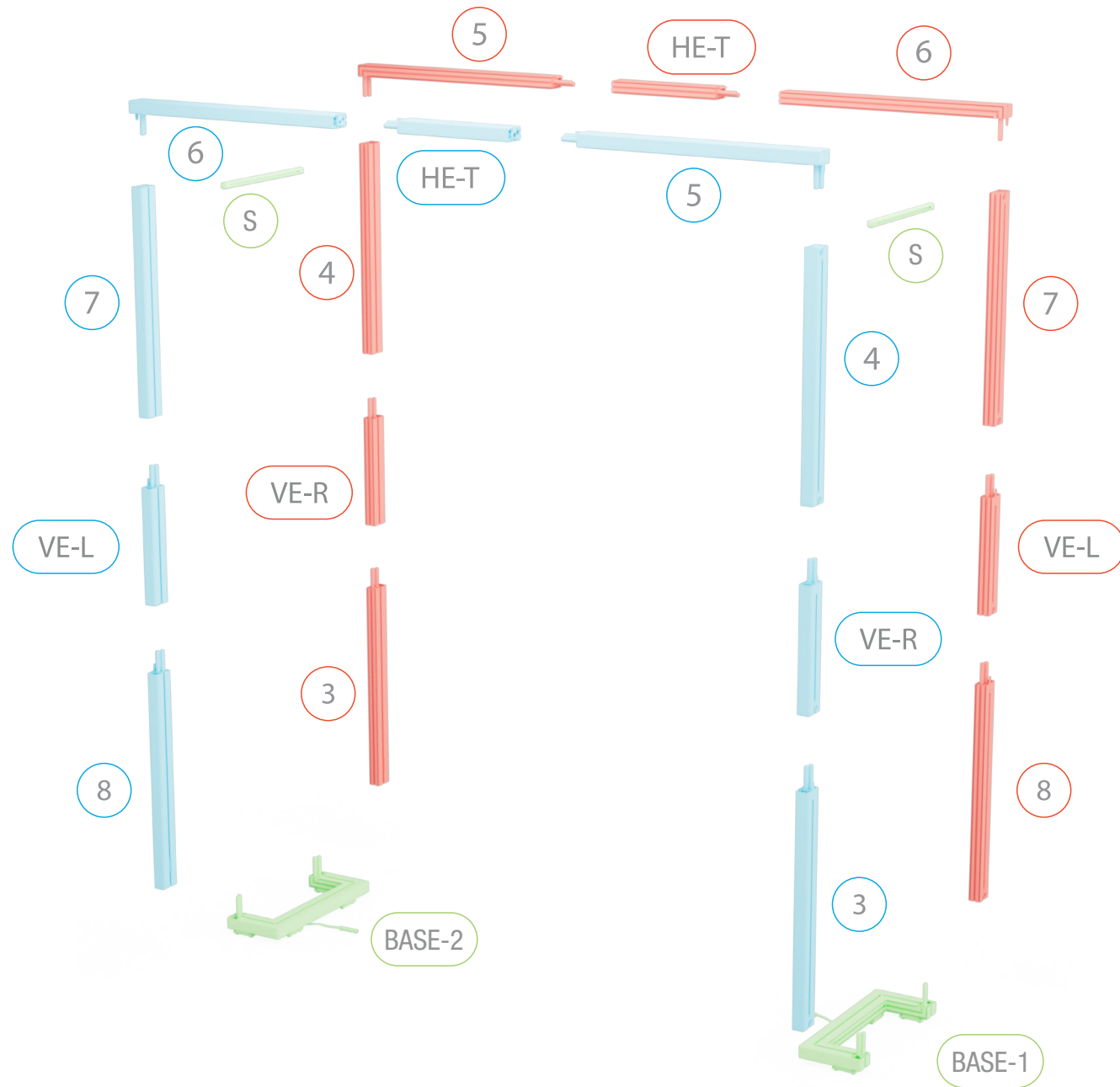

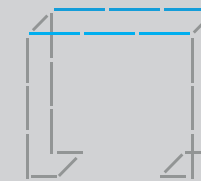
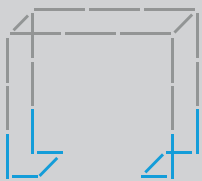

1.

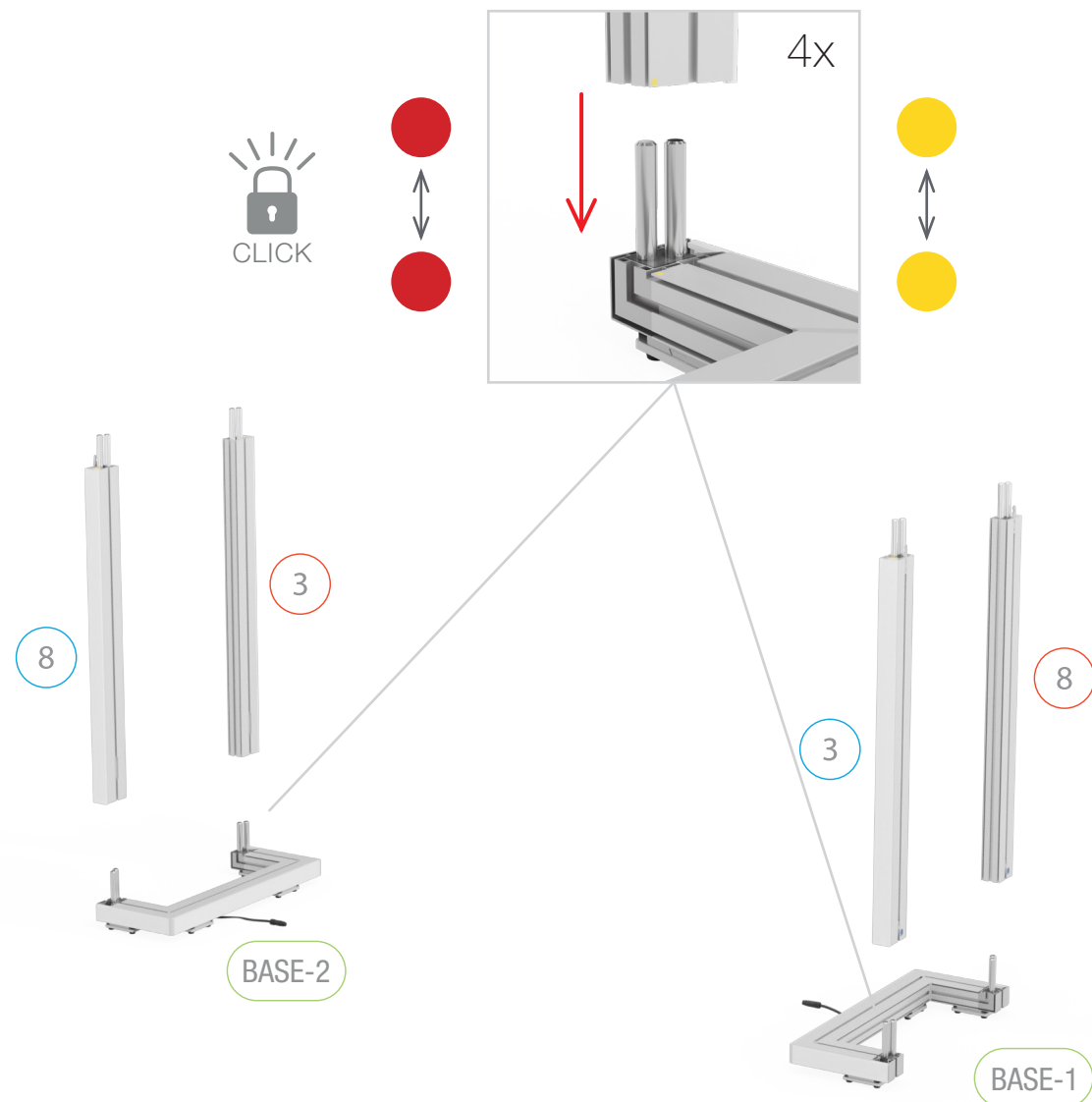

2.

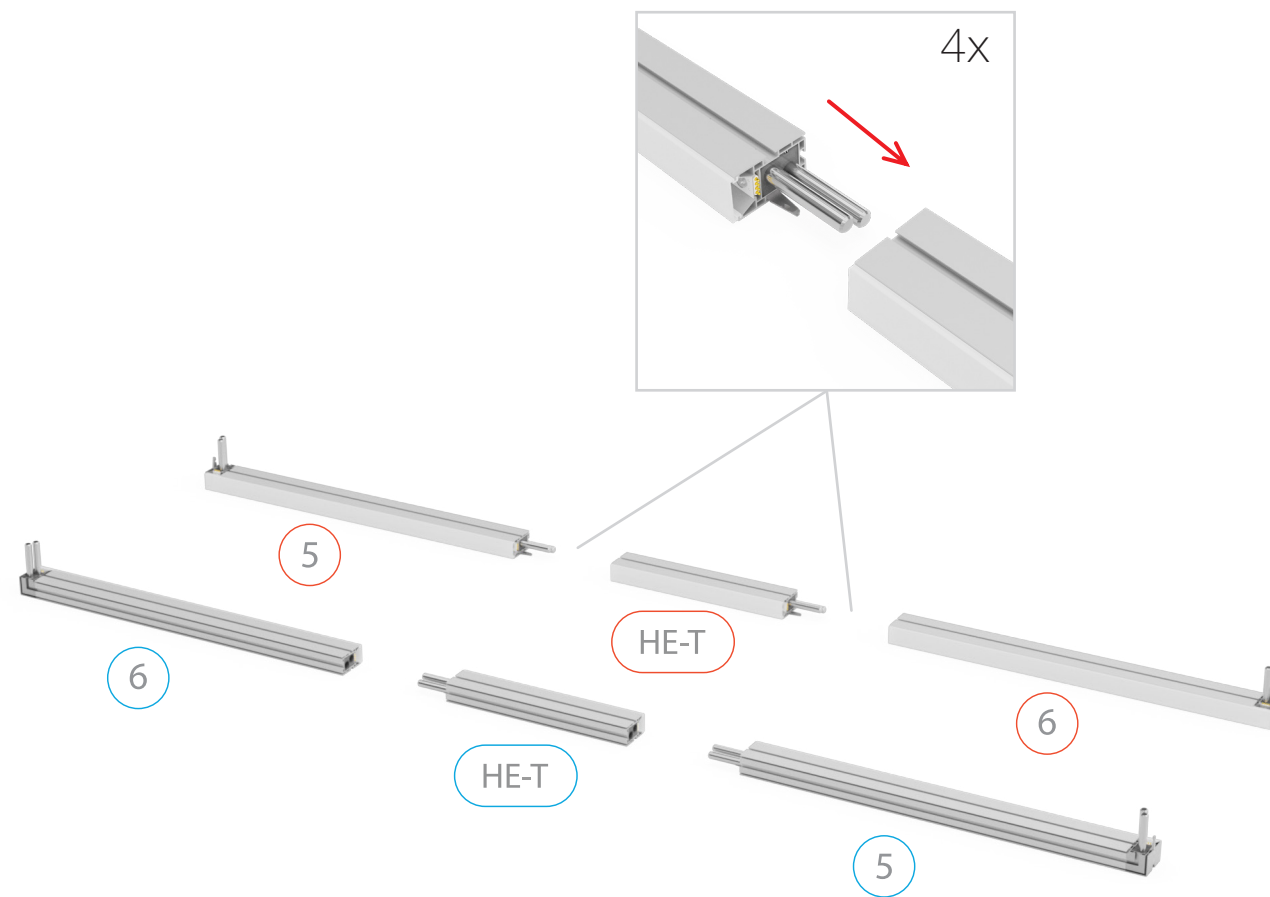

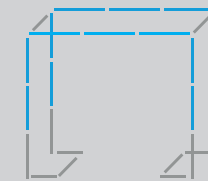
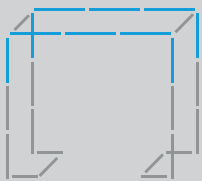

3.

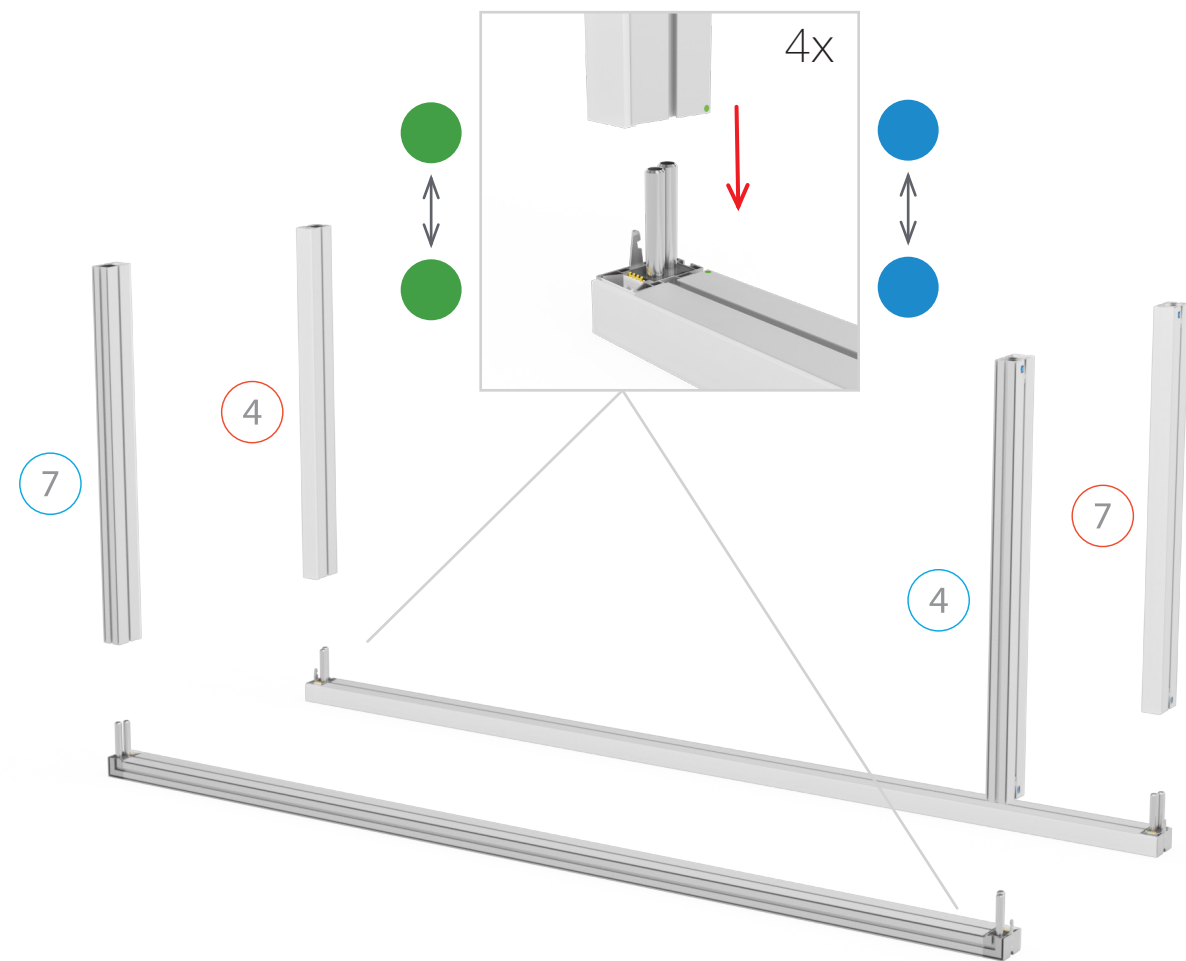

4.

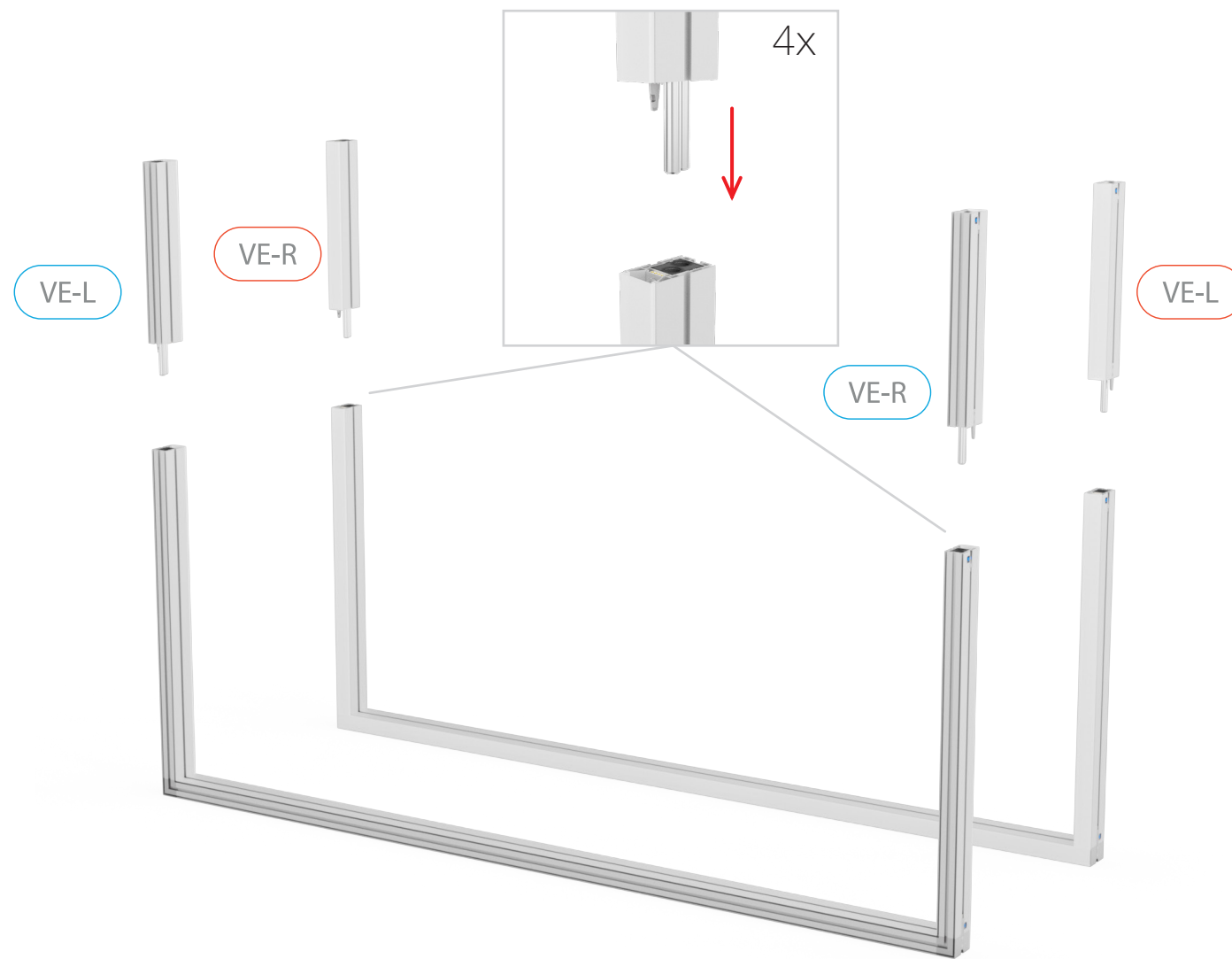

5.

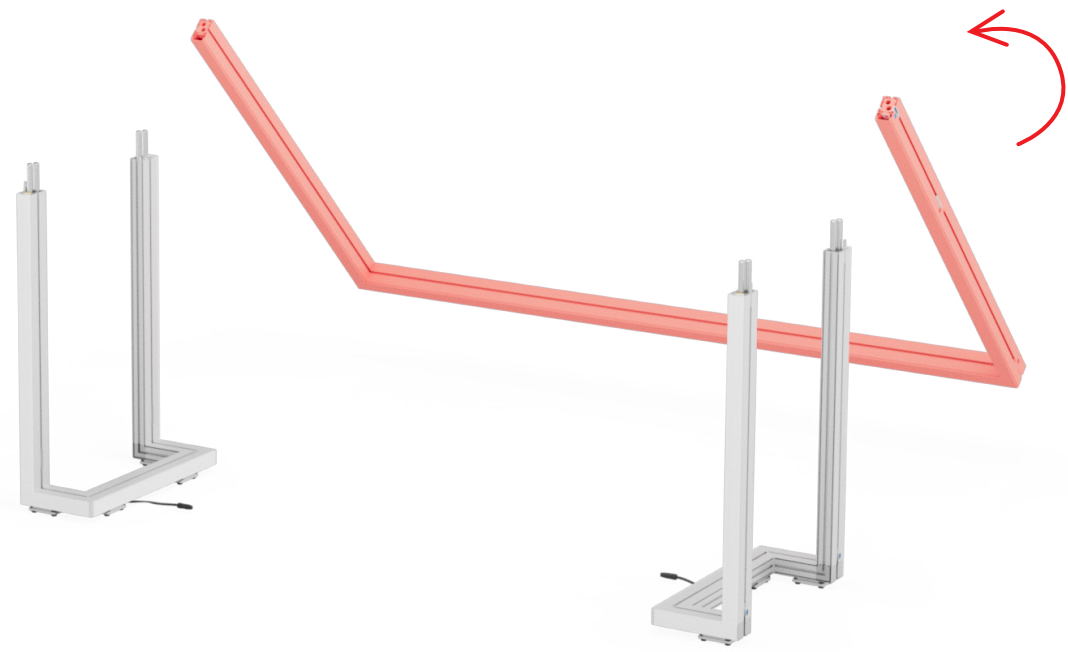

6.

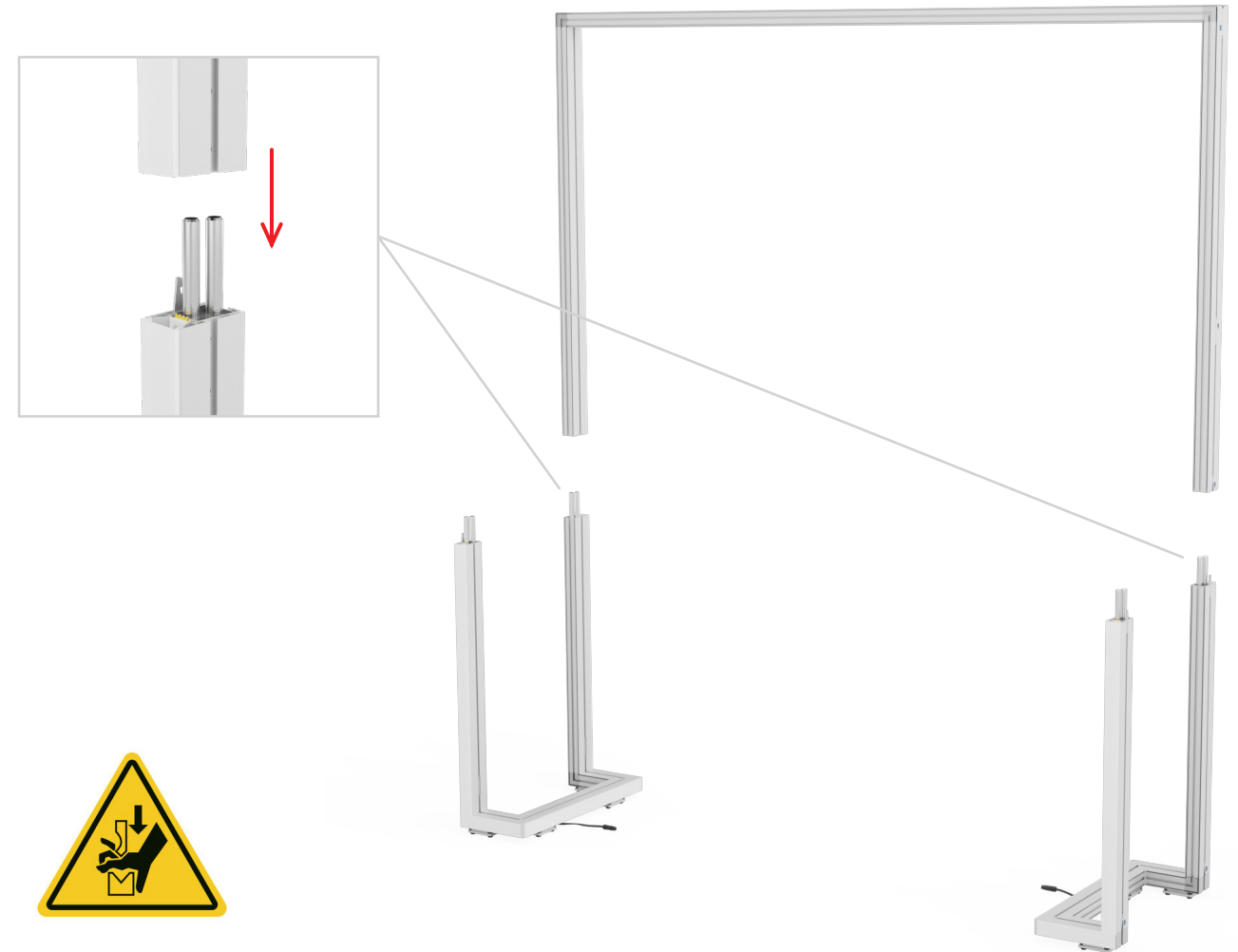

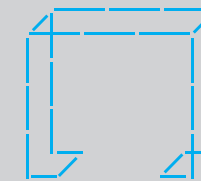
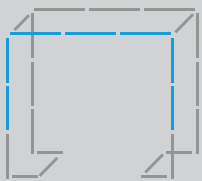

7.

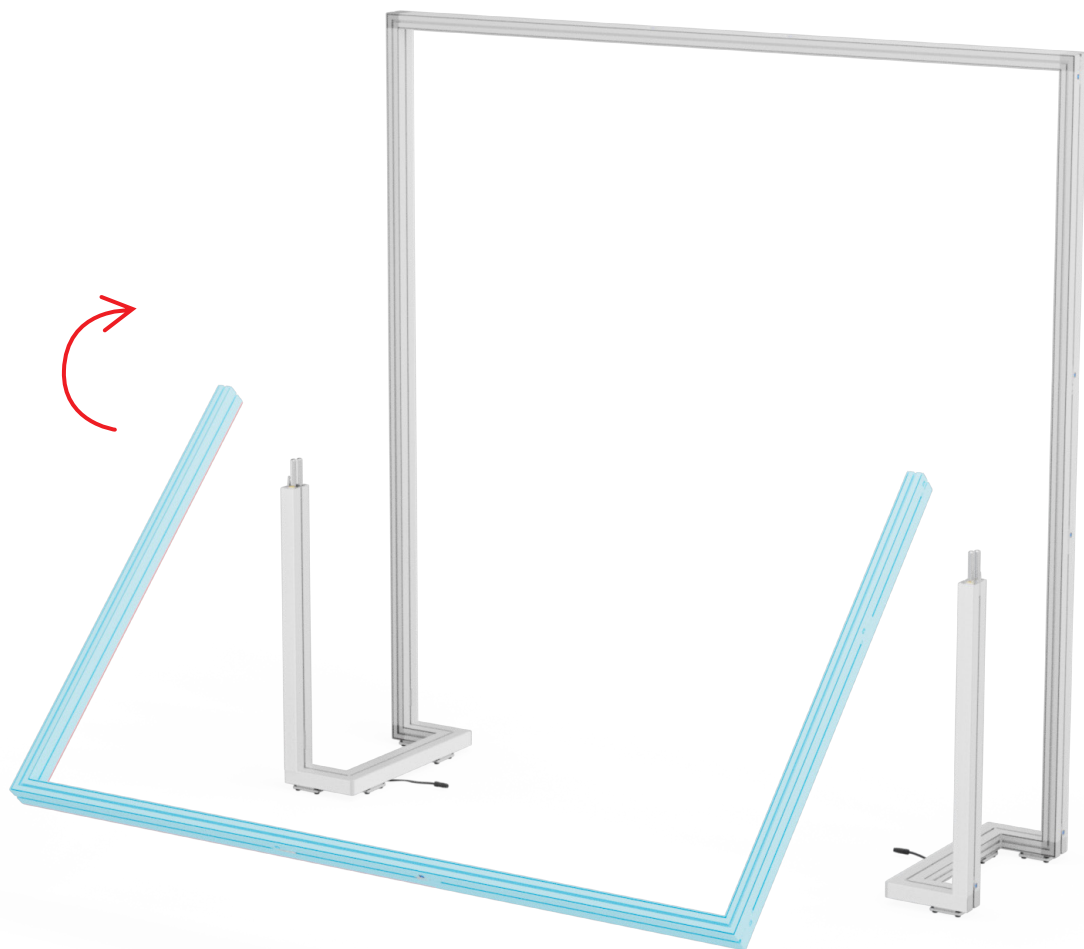

8.

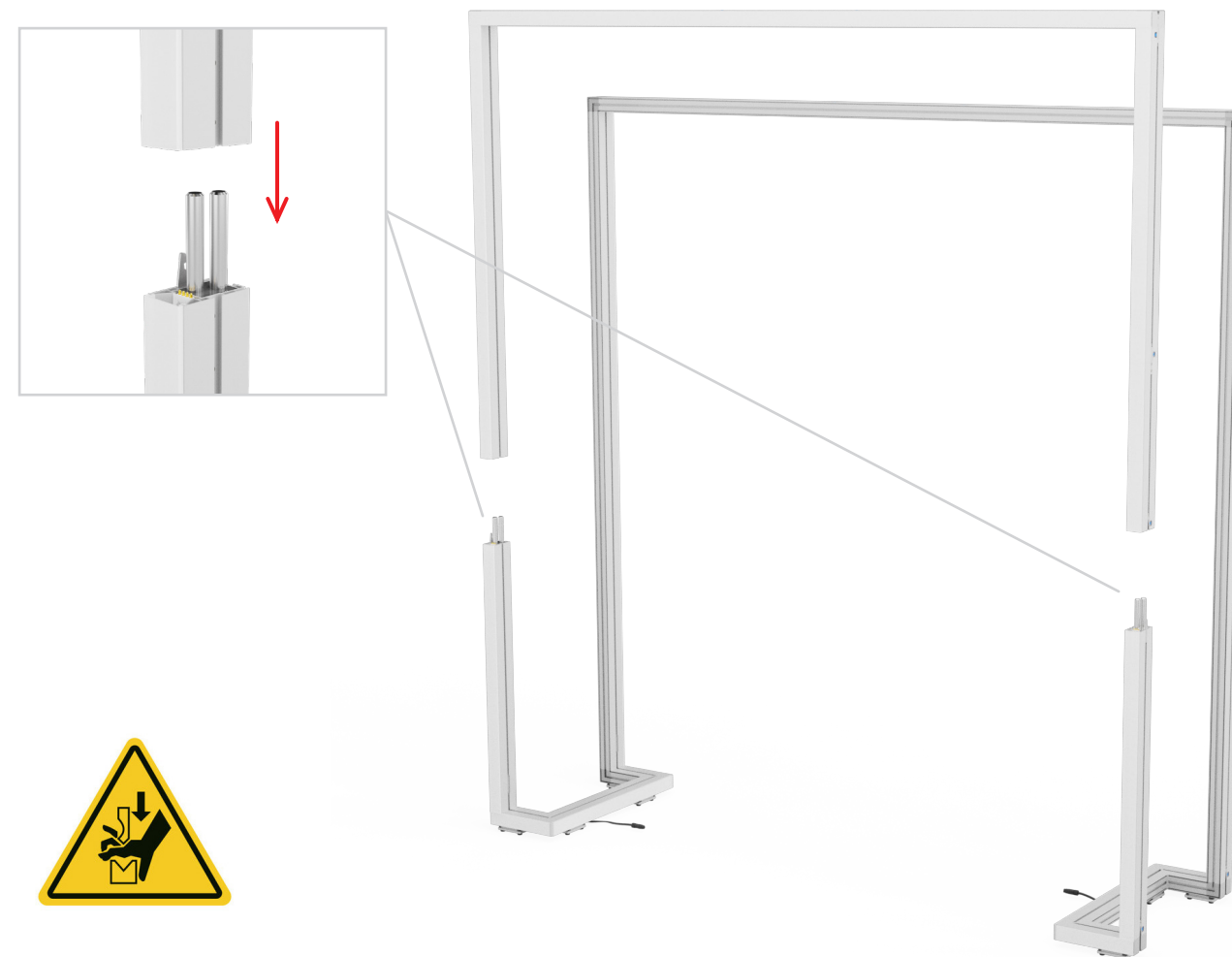

9.

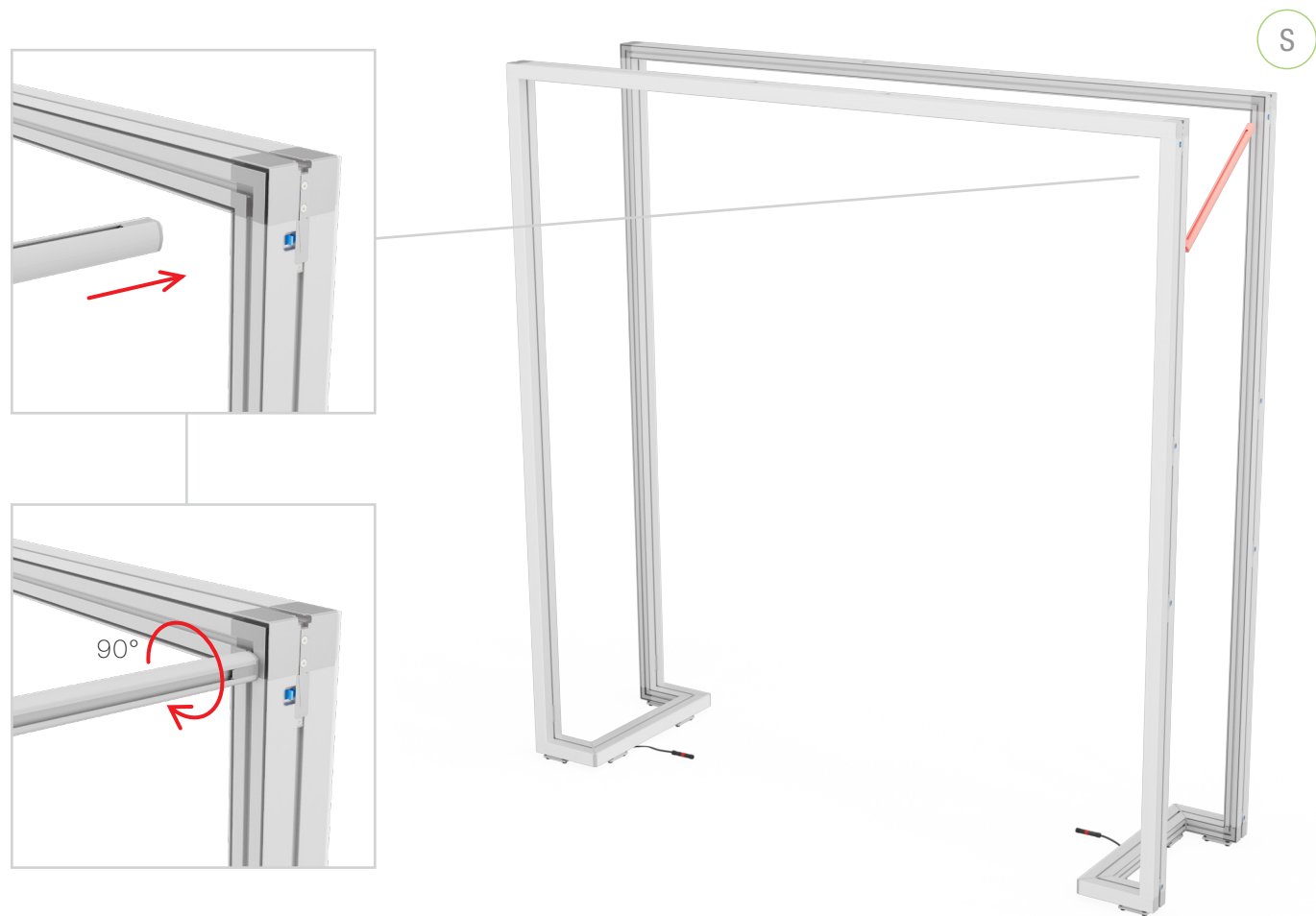

10.

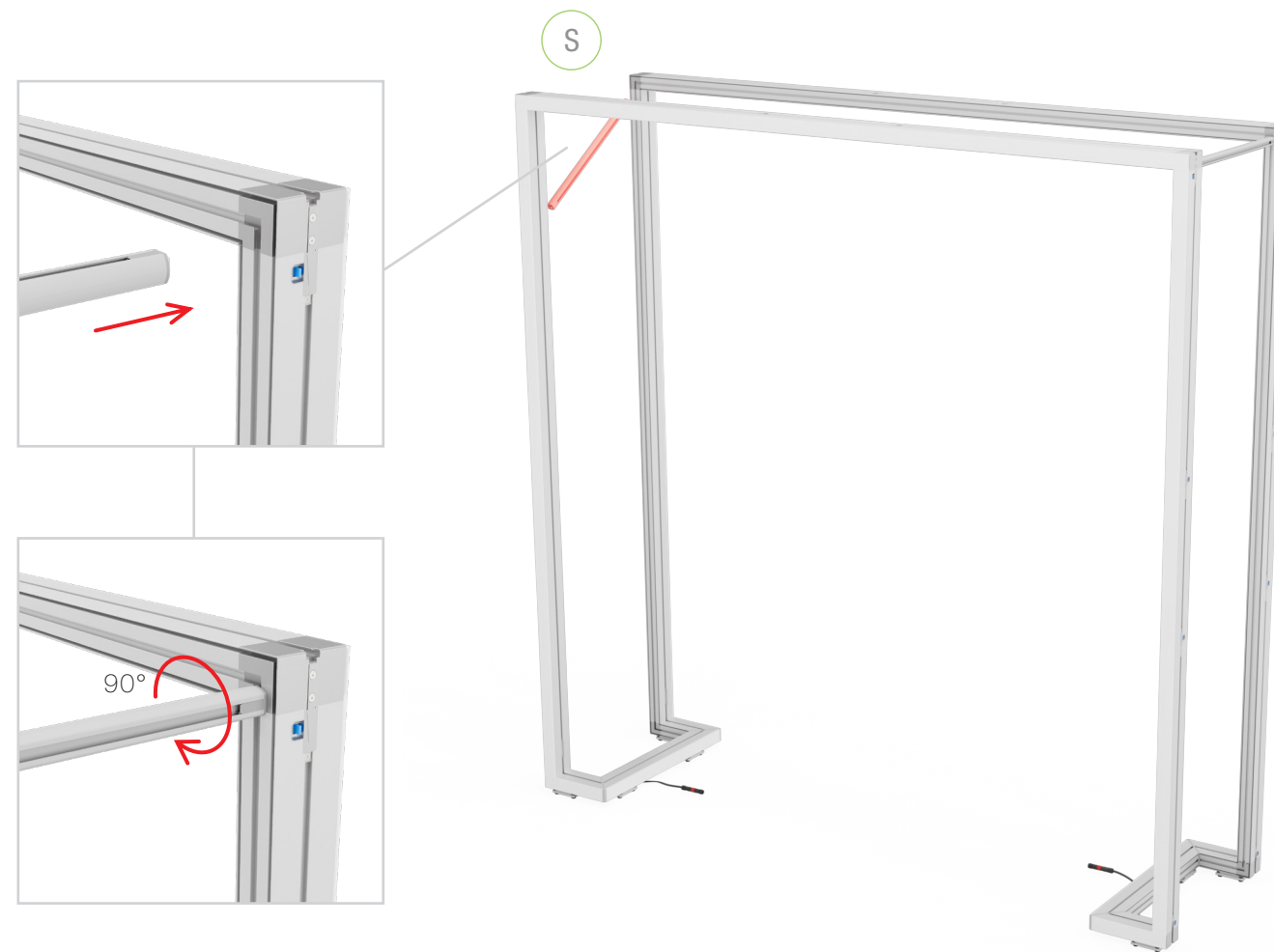

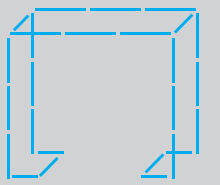
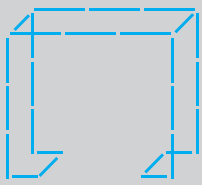

11.

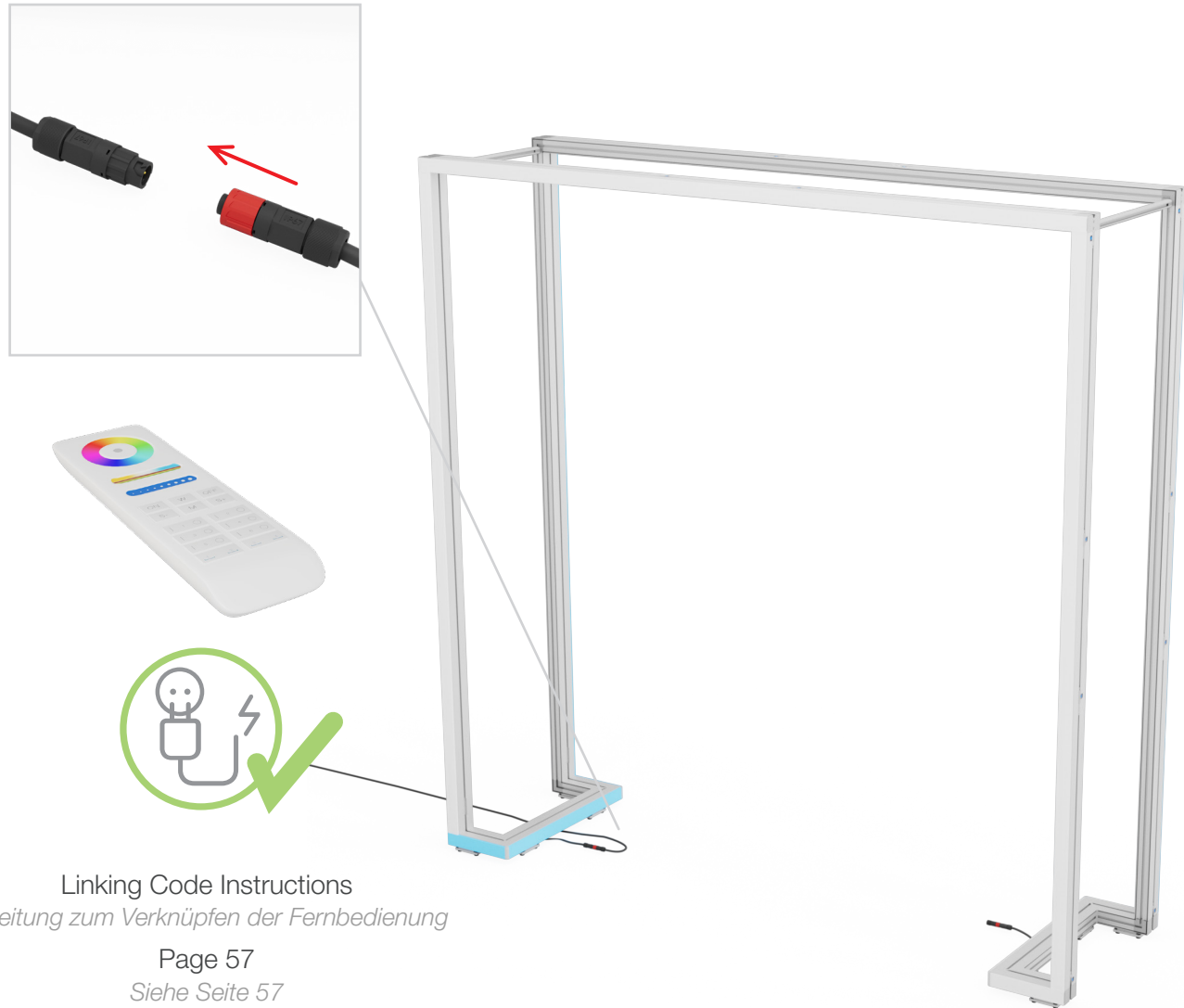

Linking Code Instructions
 Anleitung zum Verknüpfen der Fernbedienung
 Page 57
 Siehe Seite 57

12.

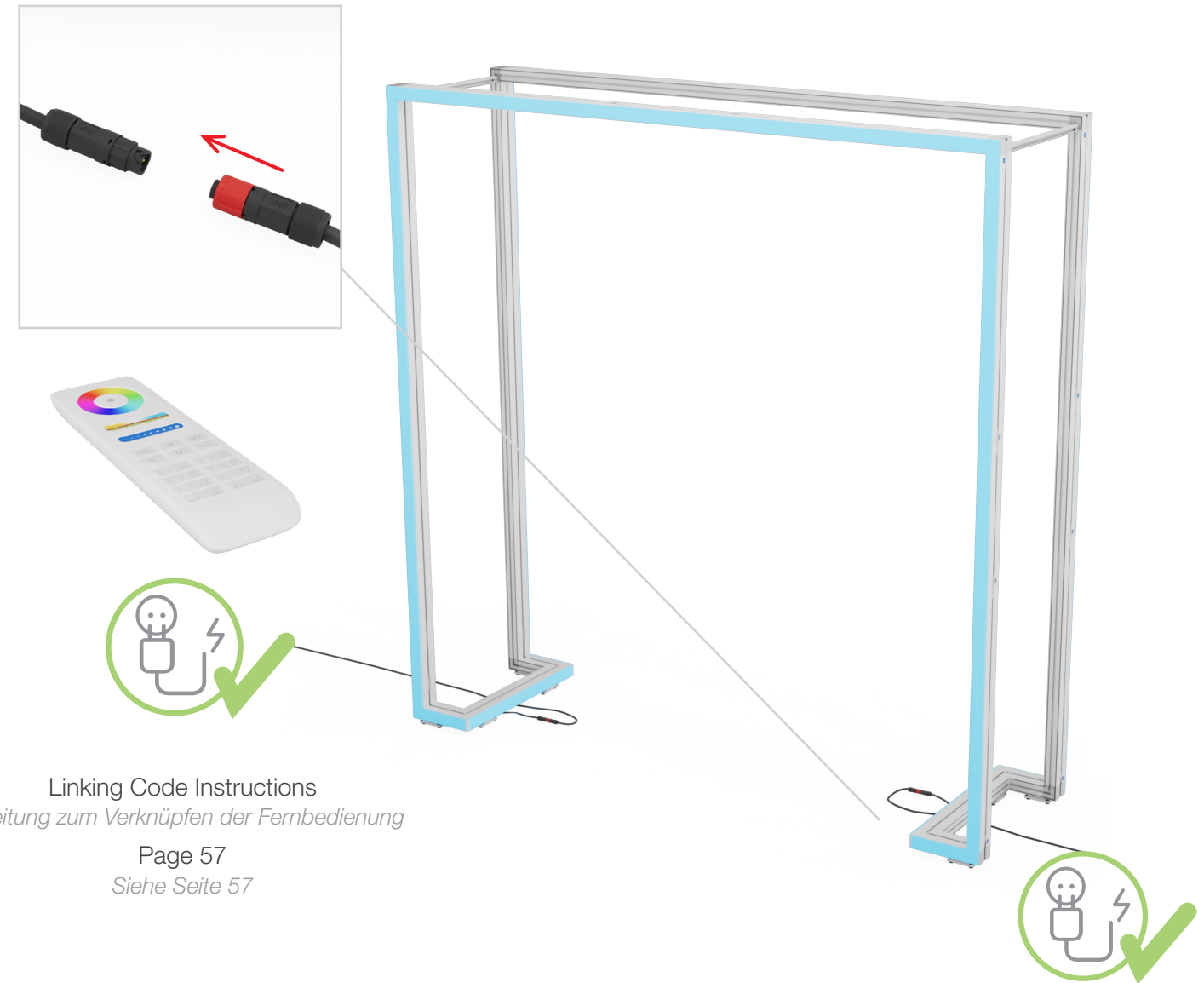

Linking Code Instructions
 Anleitung zum Verknüpfen der Fernbedienung
 Page 57
 Siehe Seite 57

6-Zone RGB LINEUP Remote

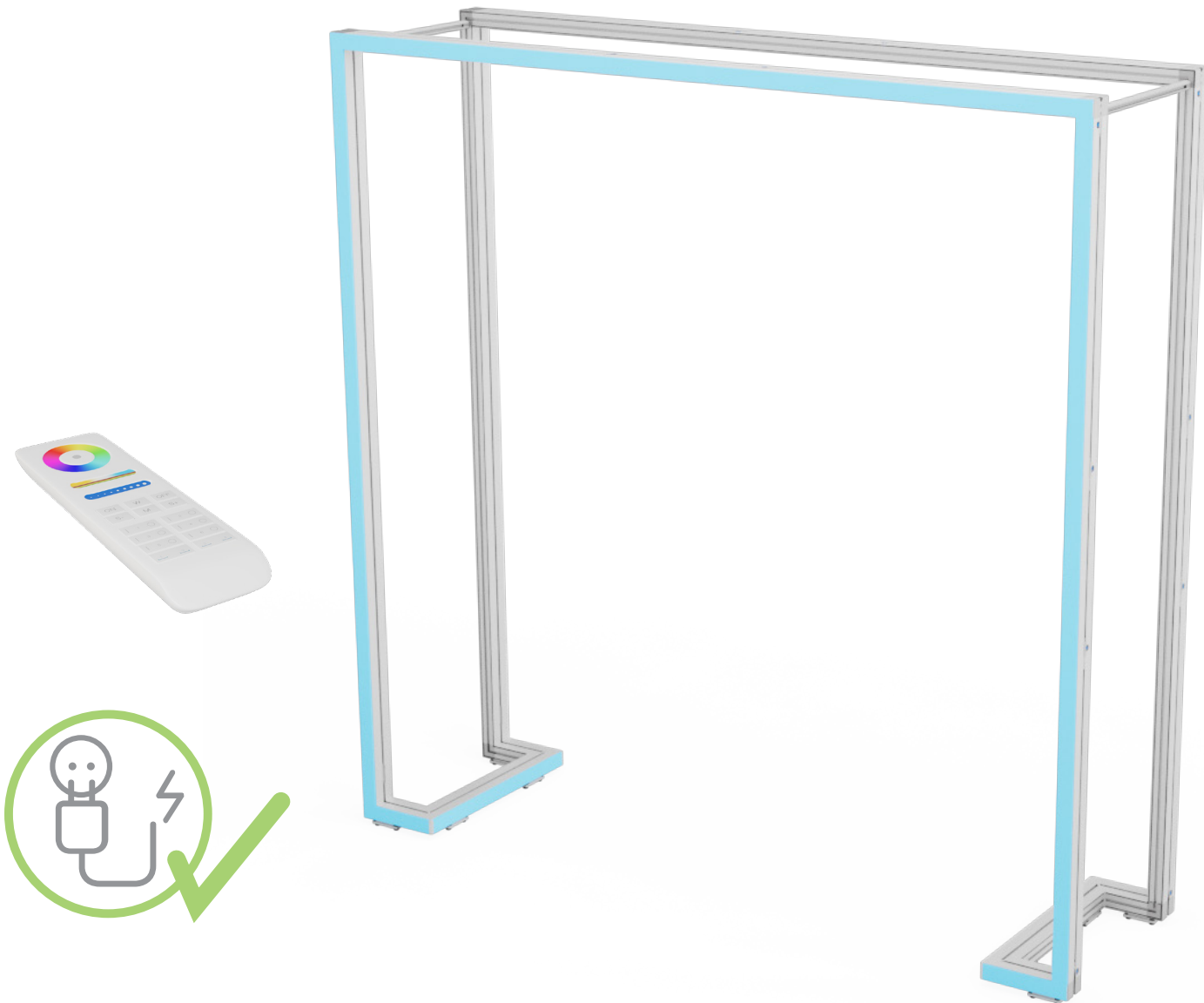

Linking Code Instructions *Anleitung zum Verknüpfen der Fernbedienung*



1

Disconnect the LINEUP frame from the power supply for 10 seconds, then reconnect it.

Stromversorgung des LINEUP-Rahmens für 10 Sekunden unterbrechen und wiederherstellen.

2

Short press "1" button 3 times within 3 seconds when light on.

Drücken Sie die Taste "1" 3 mal innerhalb von 3 Sekunden, wenn das Licht an ist.

3

Lights blink 3 times slowly means linking is done successfully.

Die Beleuchtung blinkt 3 mal langsam, dass bedeutet die Verknüpfung wurde erfolgreich durchgeführt.



Linking failed if light is not blinking slowly, Please follow above steps again.
(Note: Light that have linked can't link again)

*Die Verknüpfung ist fehlgeschlagen, wenn das Licht nicht langsam blinkt.
Bitte befolgen Sie die obigen Schritte erneut.
(Hinweis: Licht, welches verknüpft ist, kann nicht erneut verknüpft werden)*

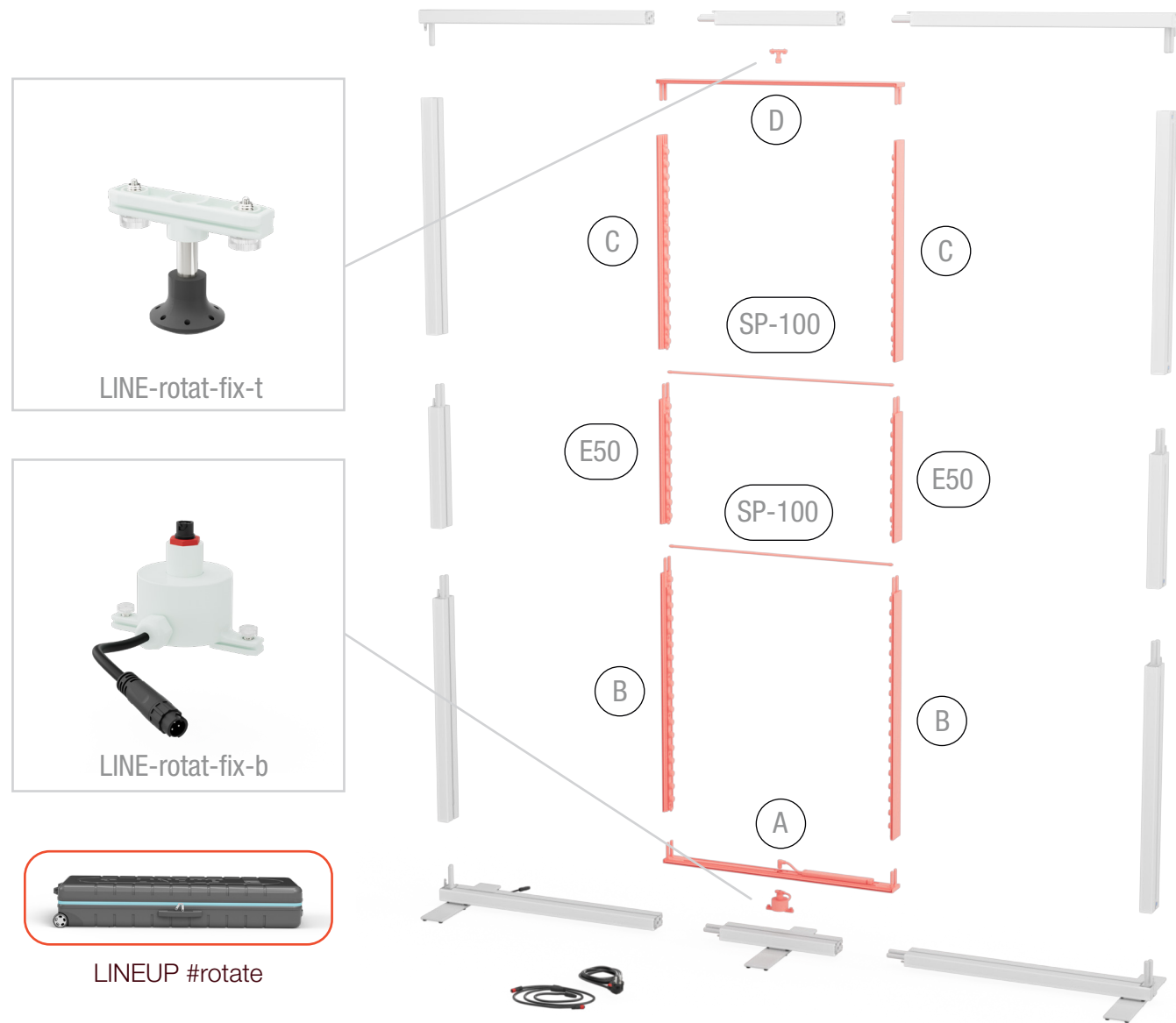

1.

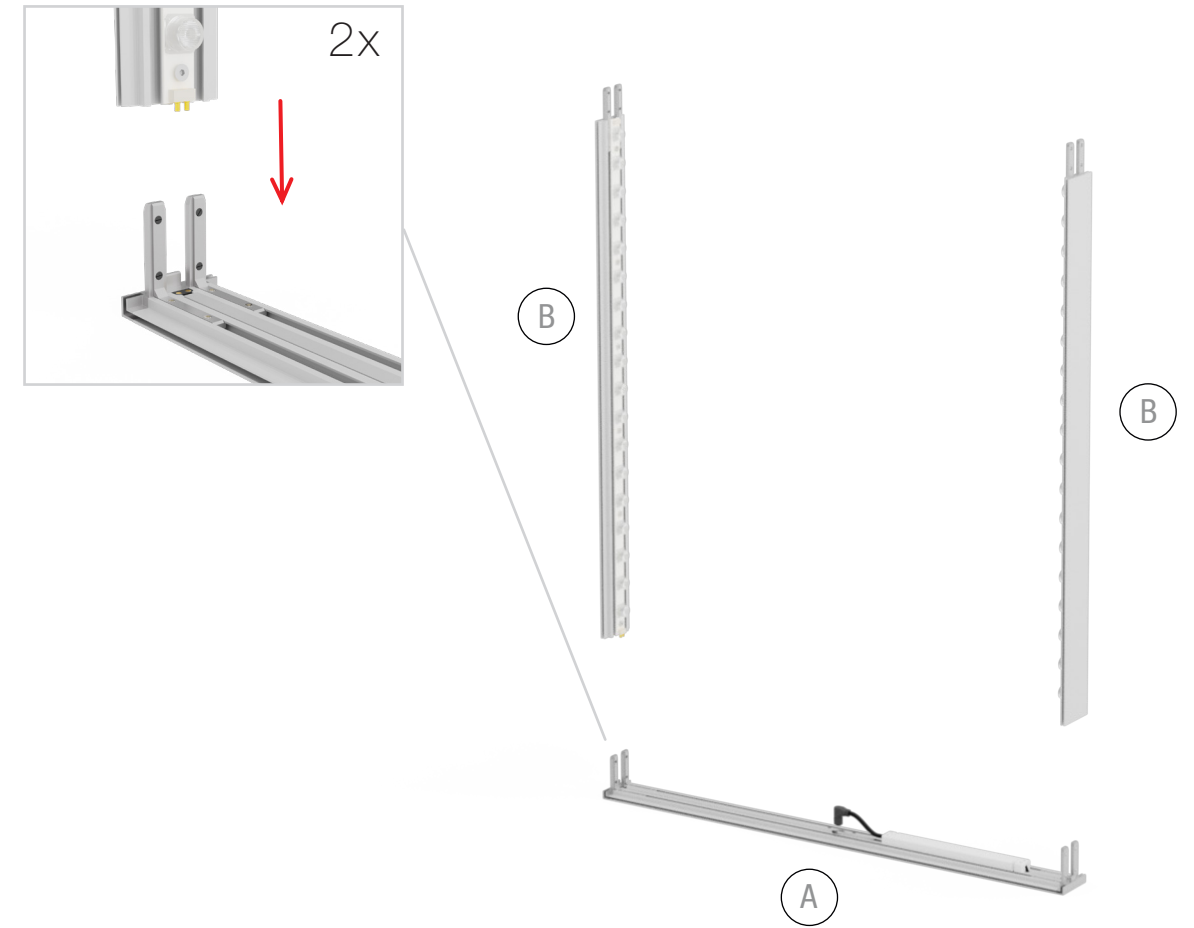

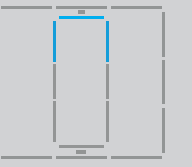
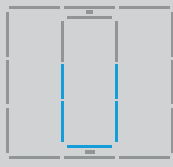

2.

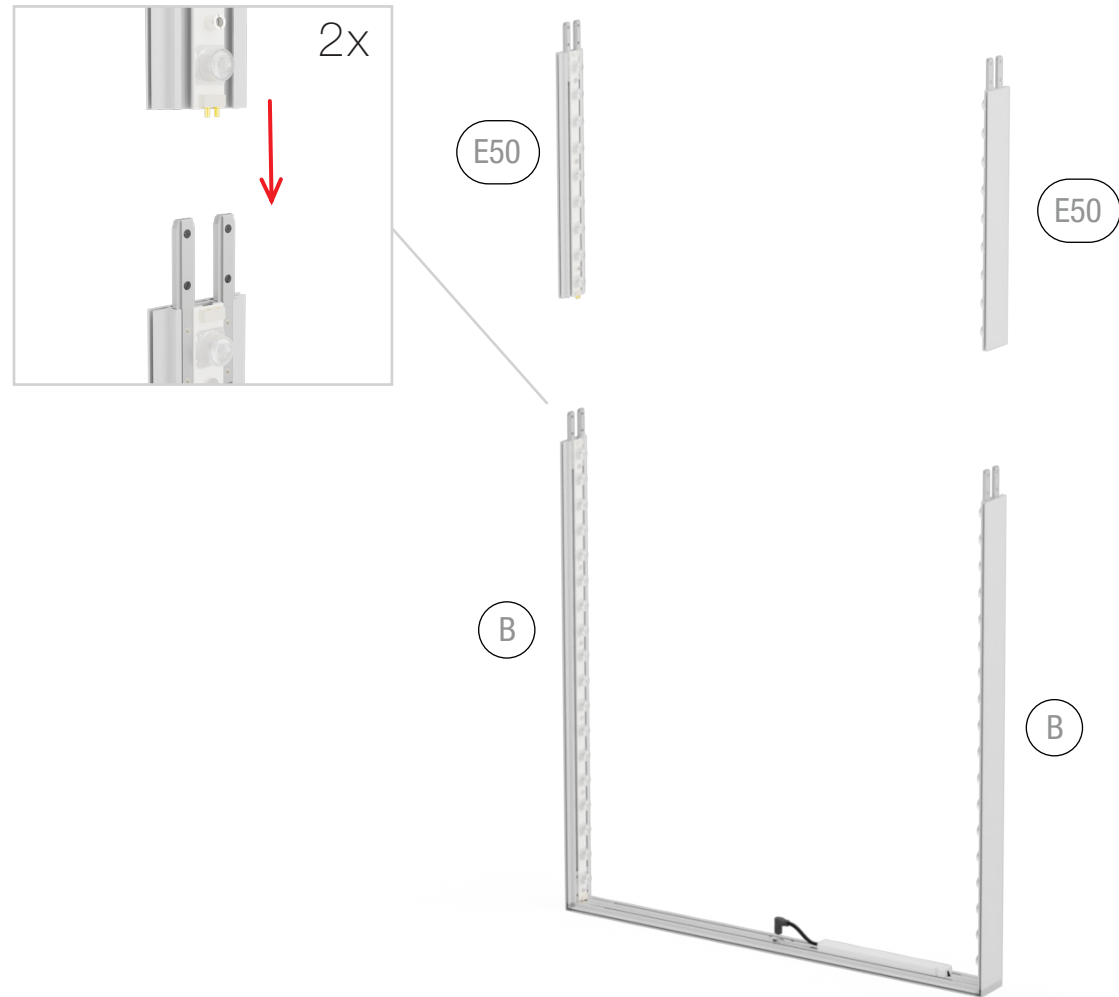

3.

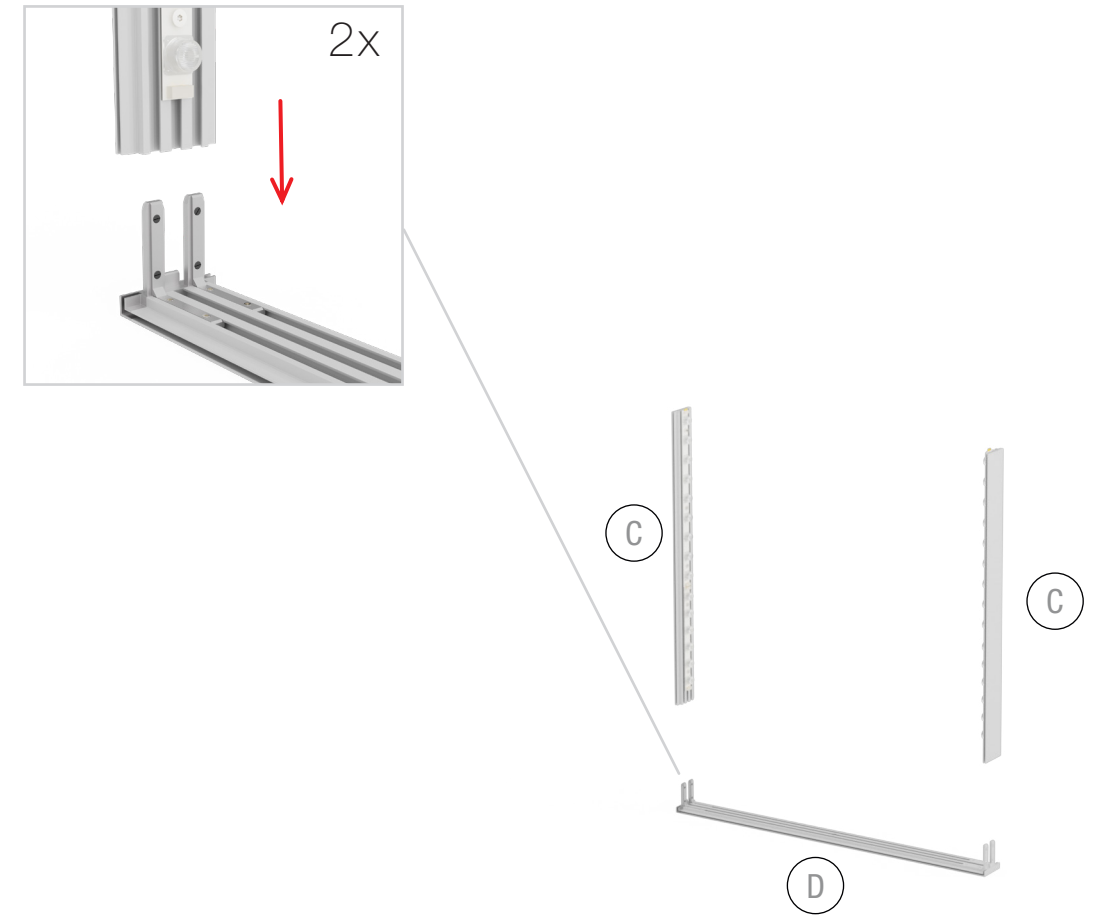

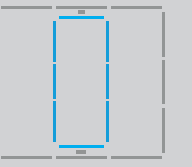
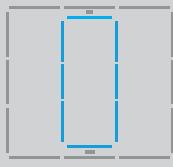

4.

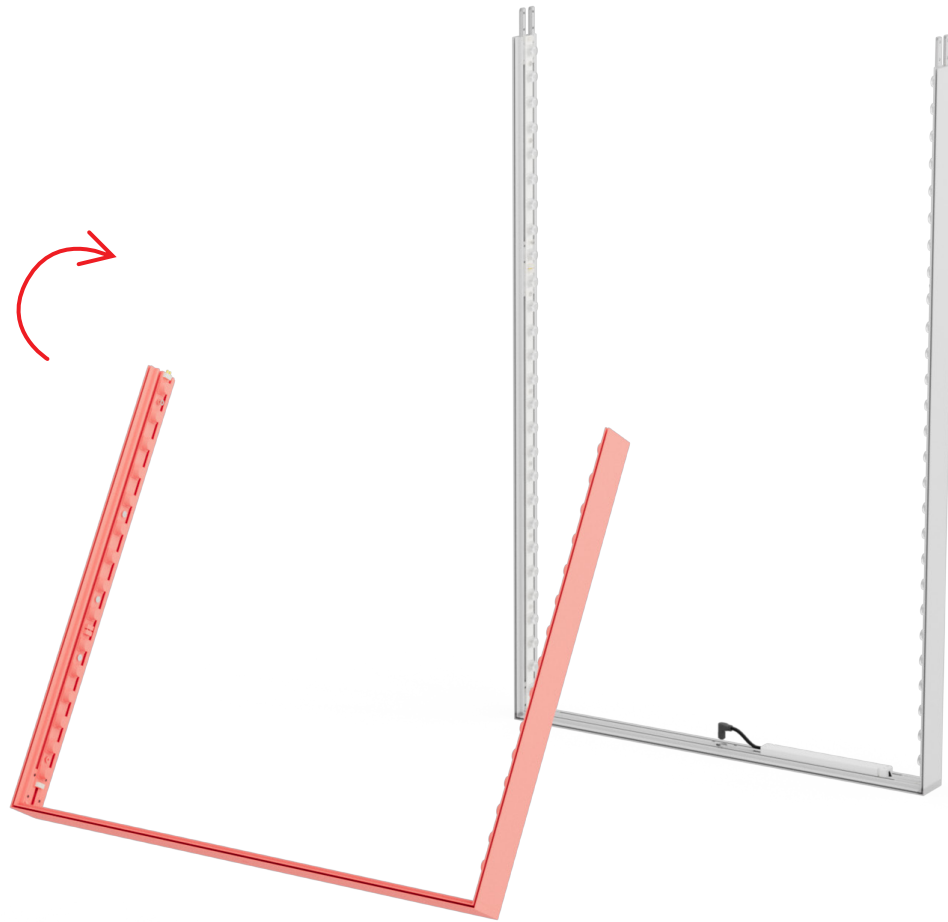

5.

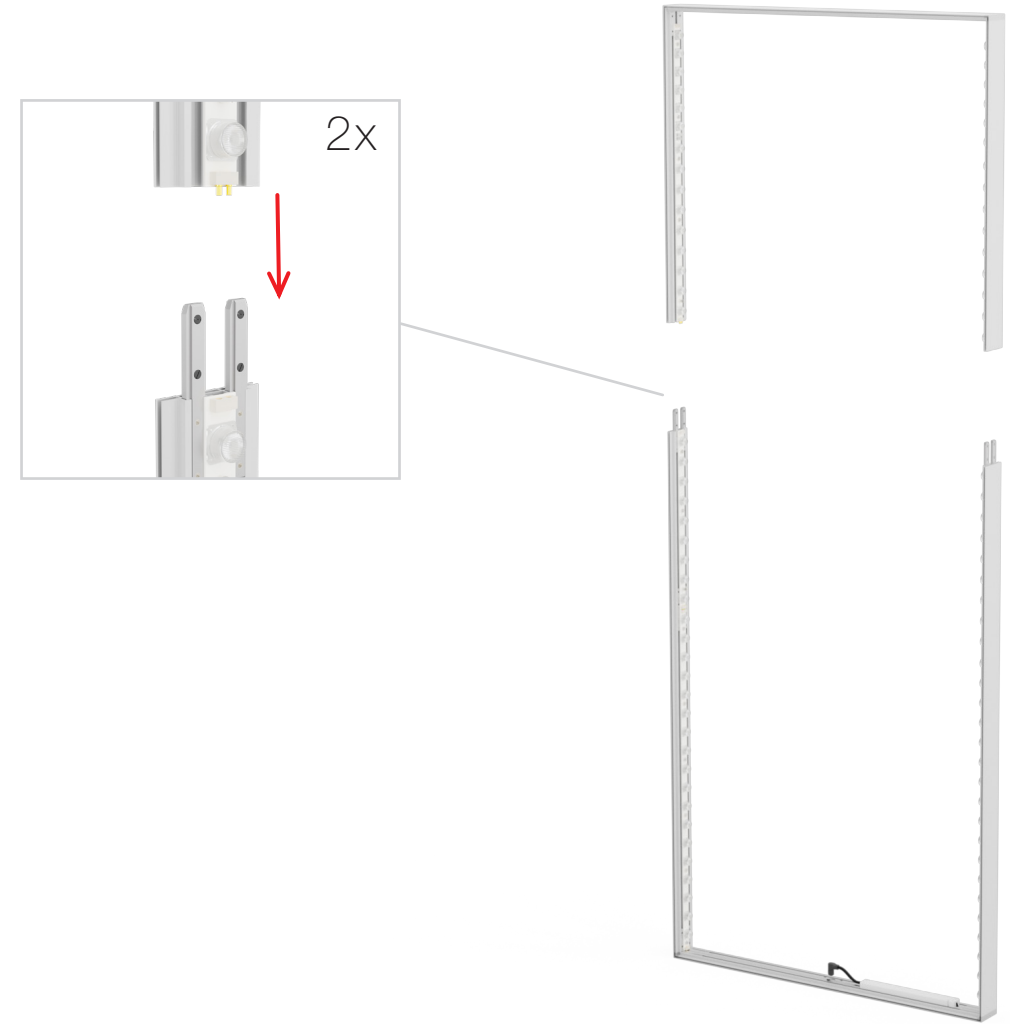

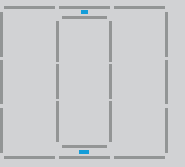
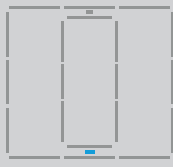

6.

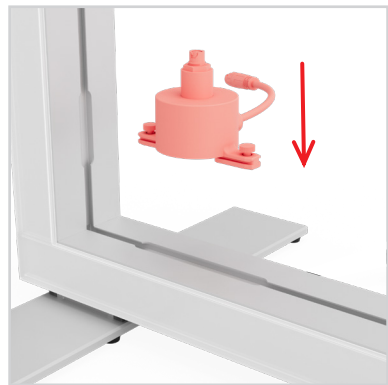

7.

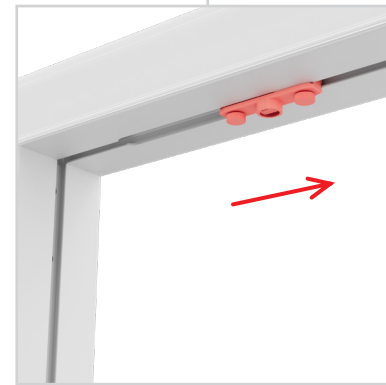
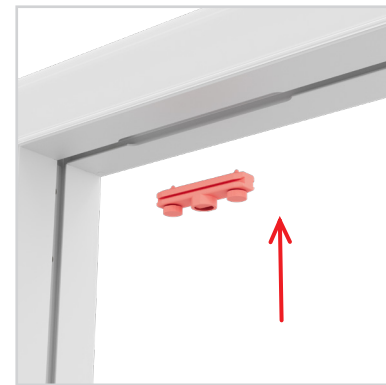

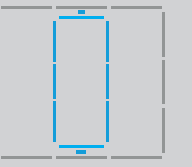
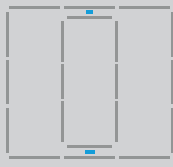

8.

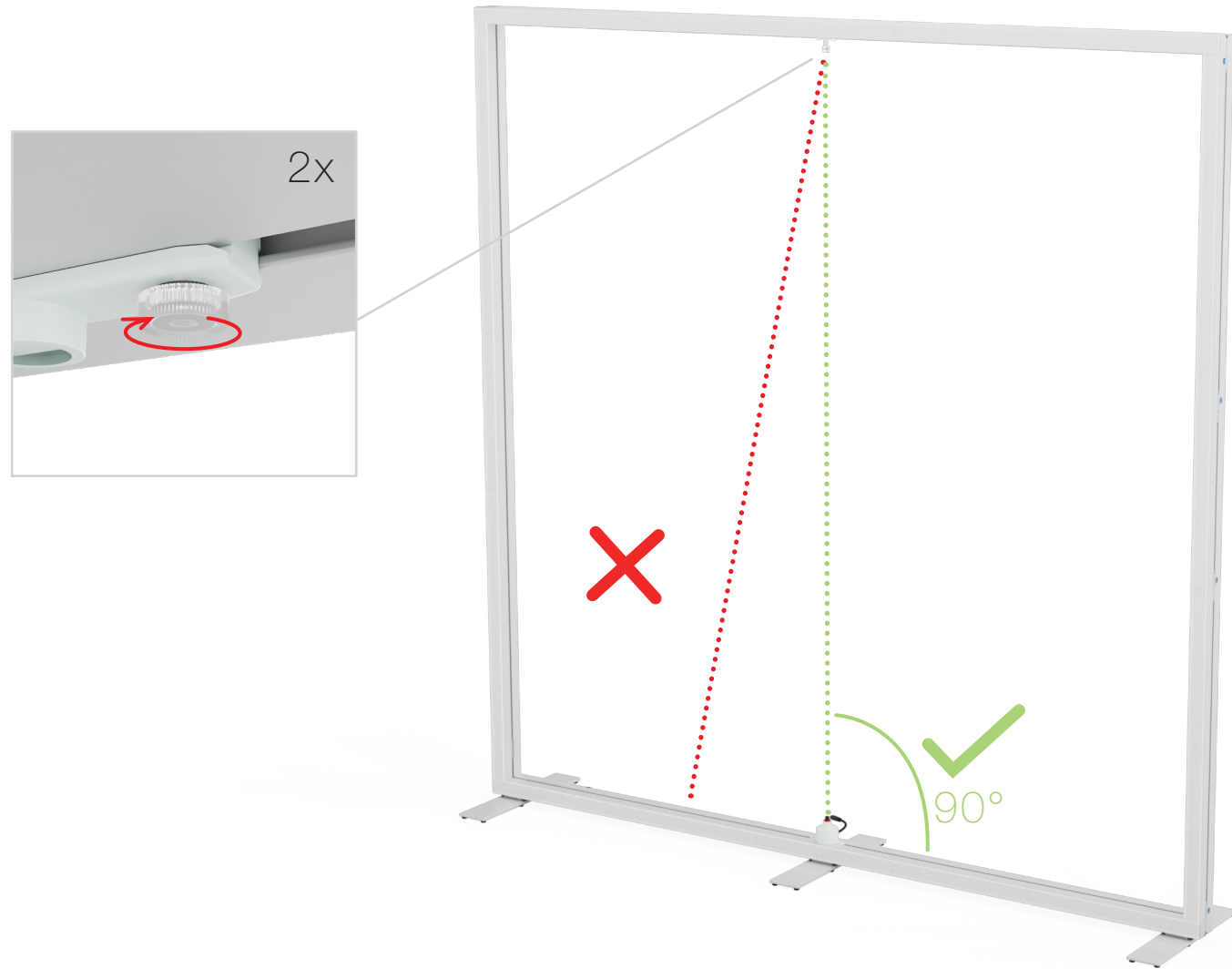

9.

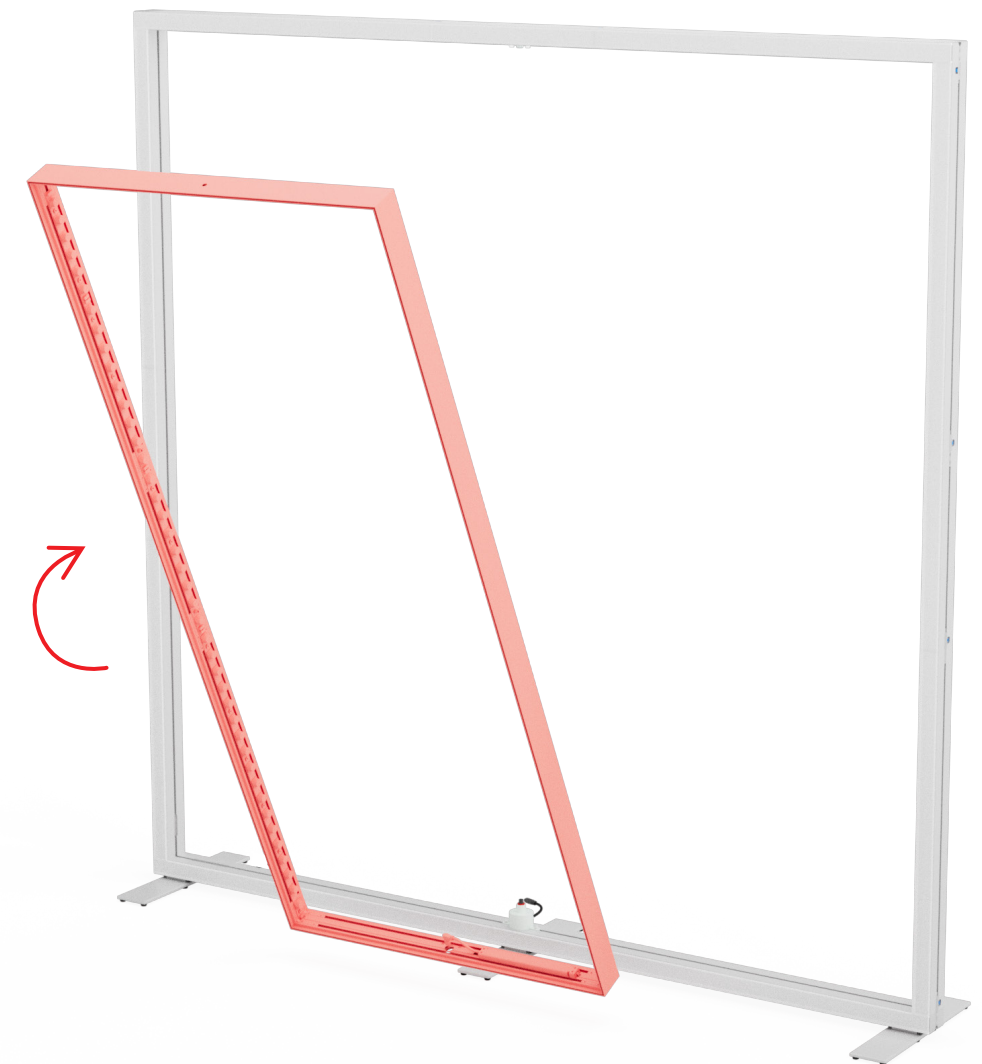

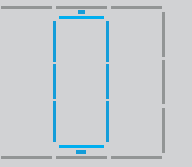
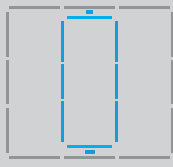

10.

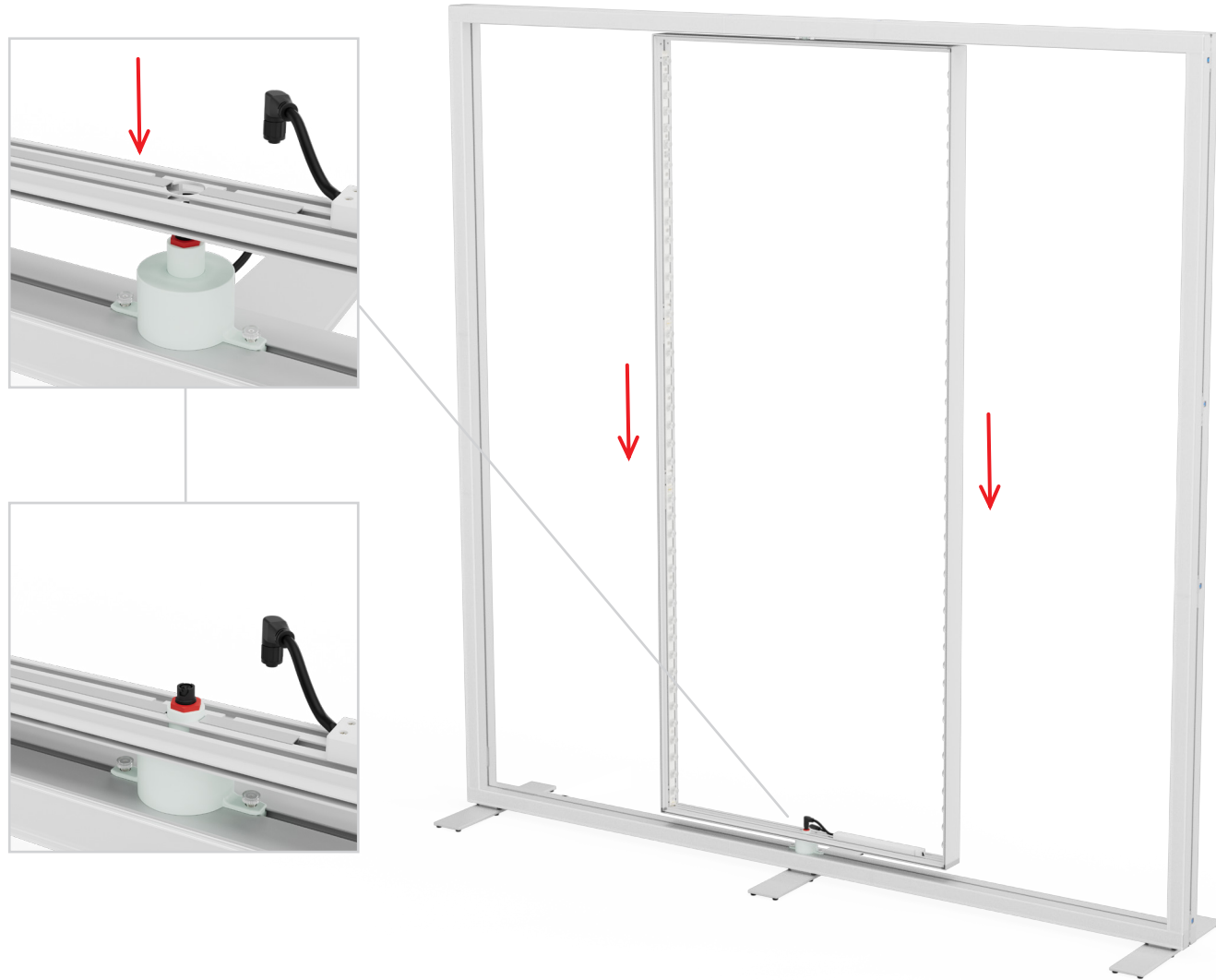

11.

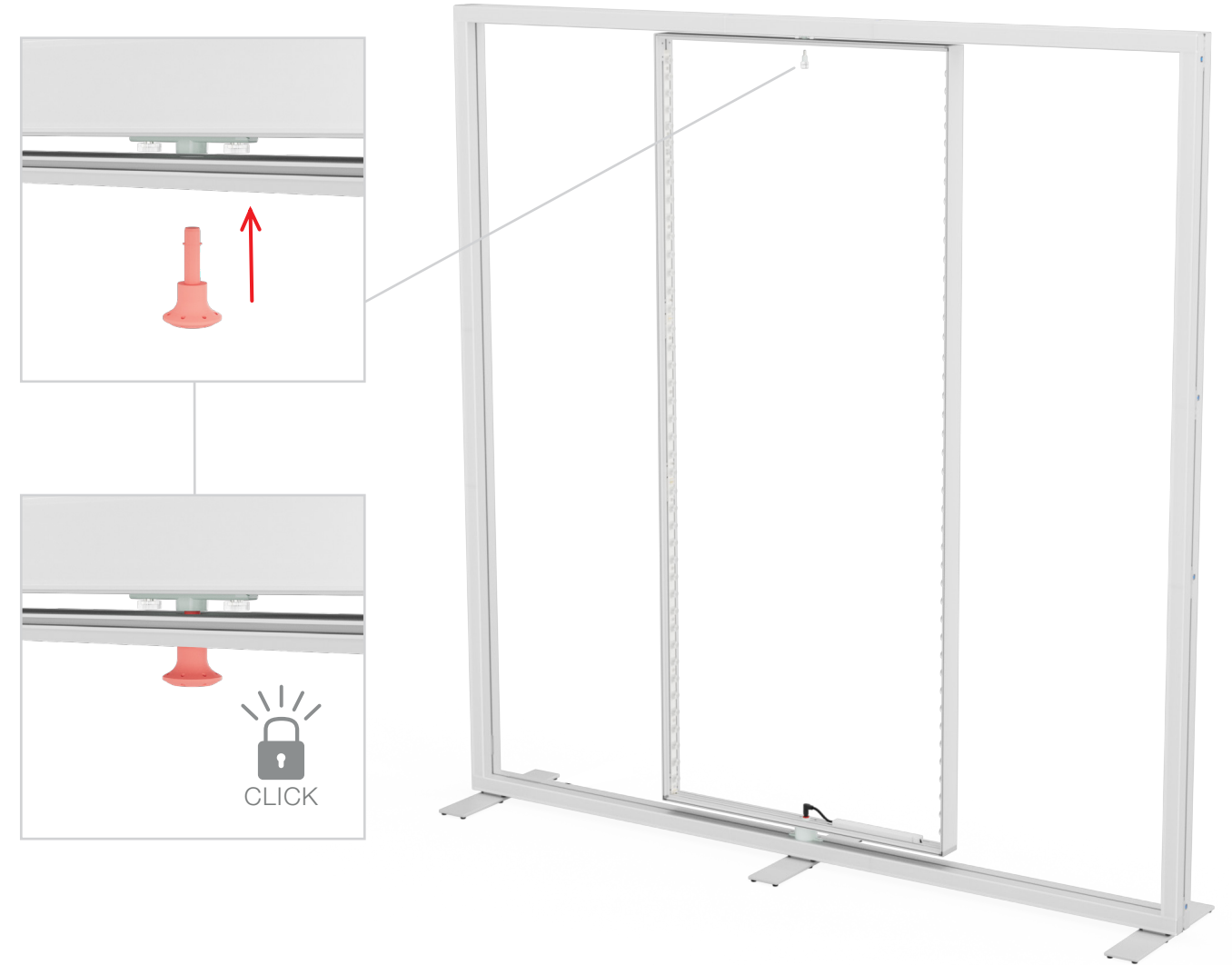

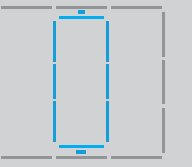
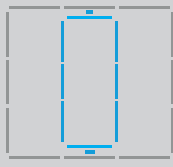

12.

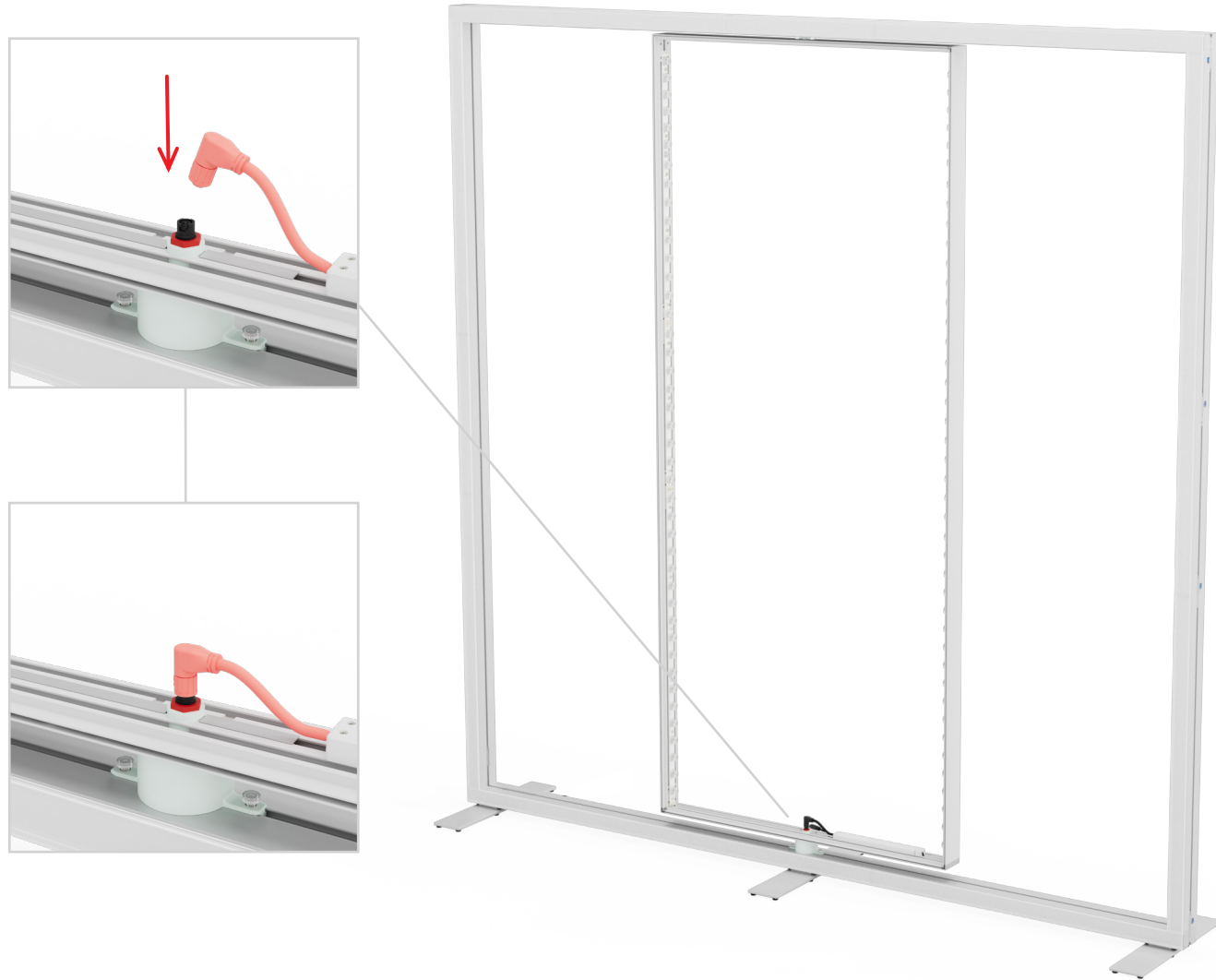

13.

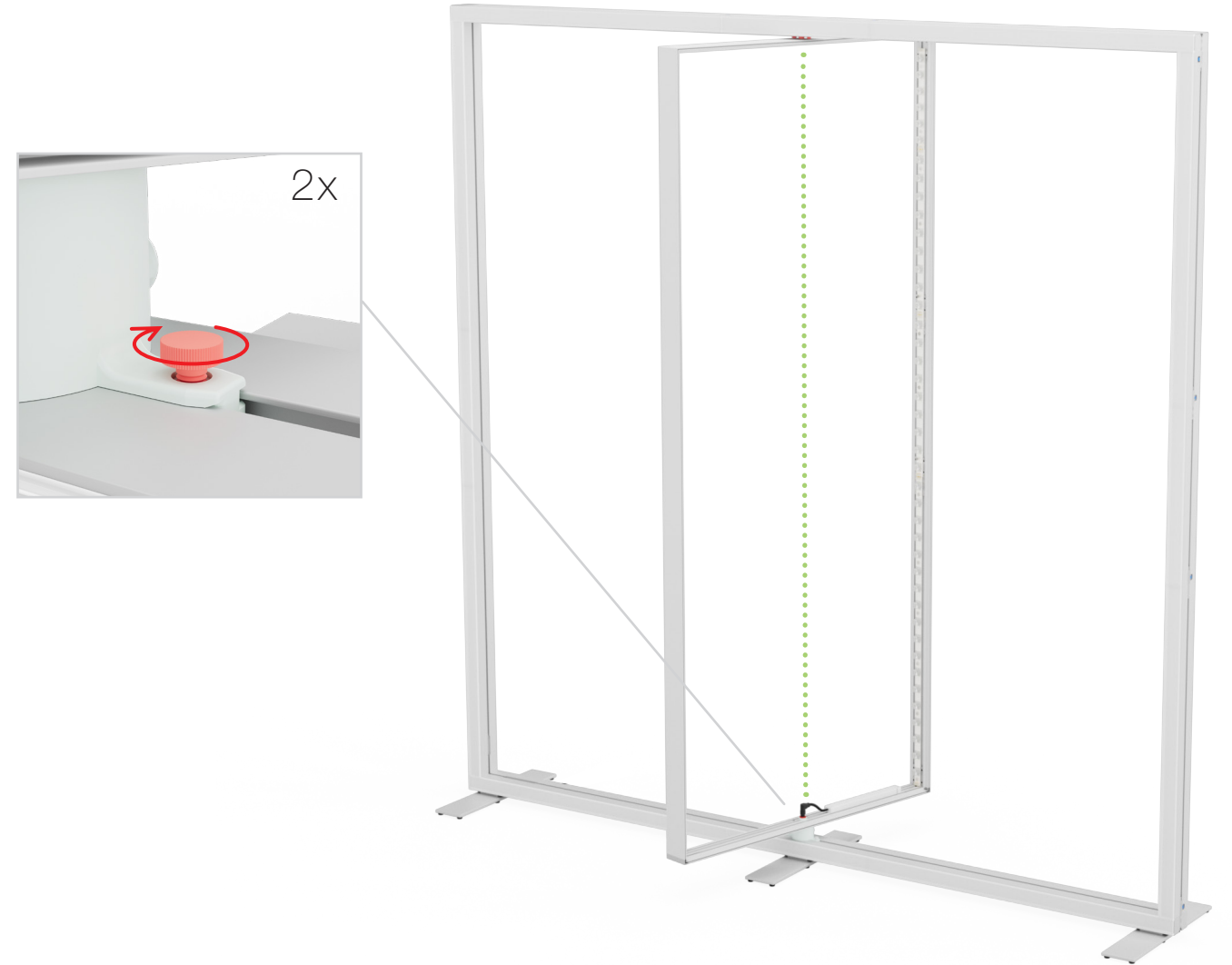

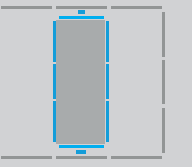
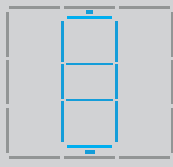

14.

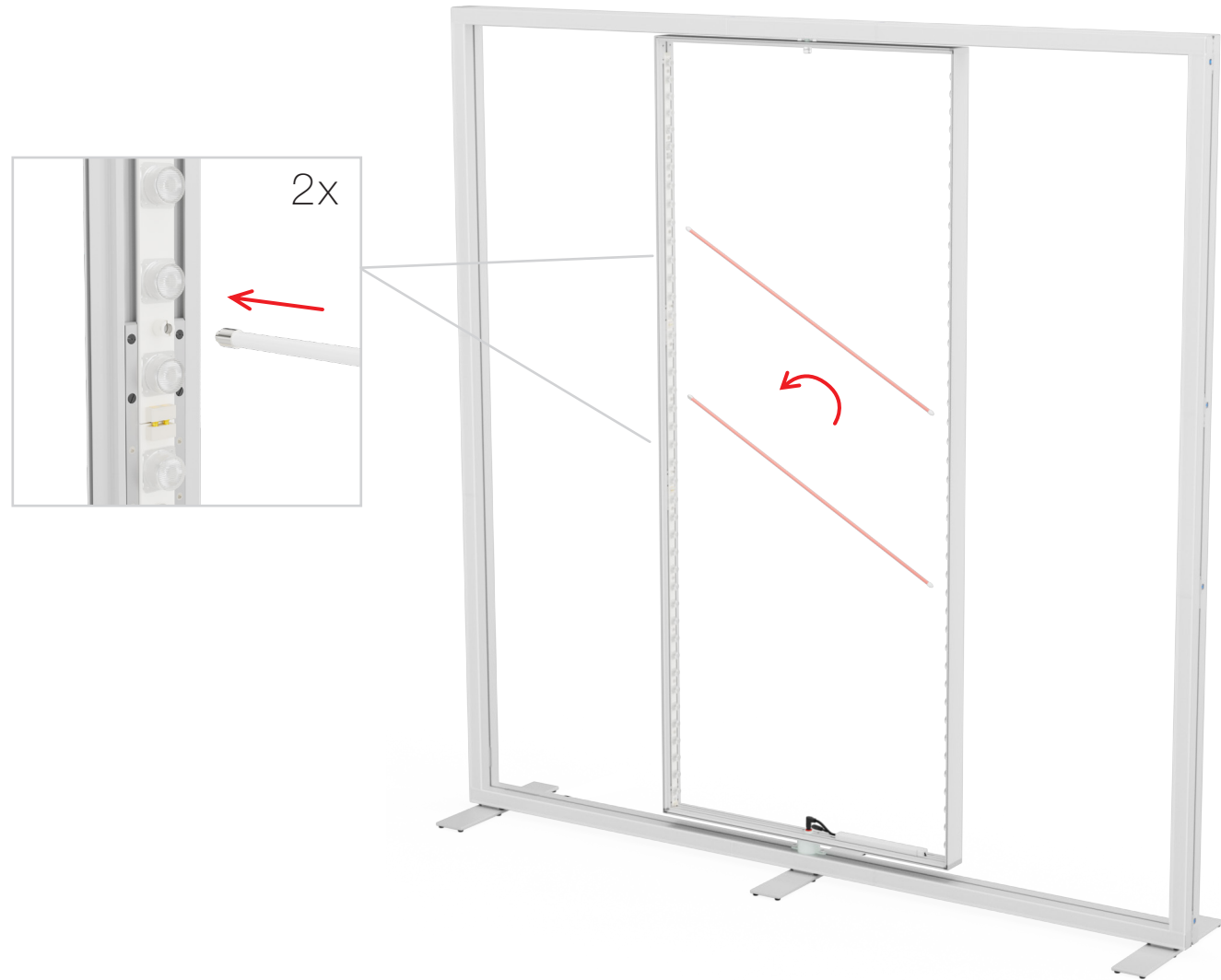

15.

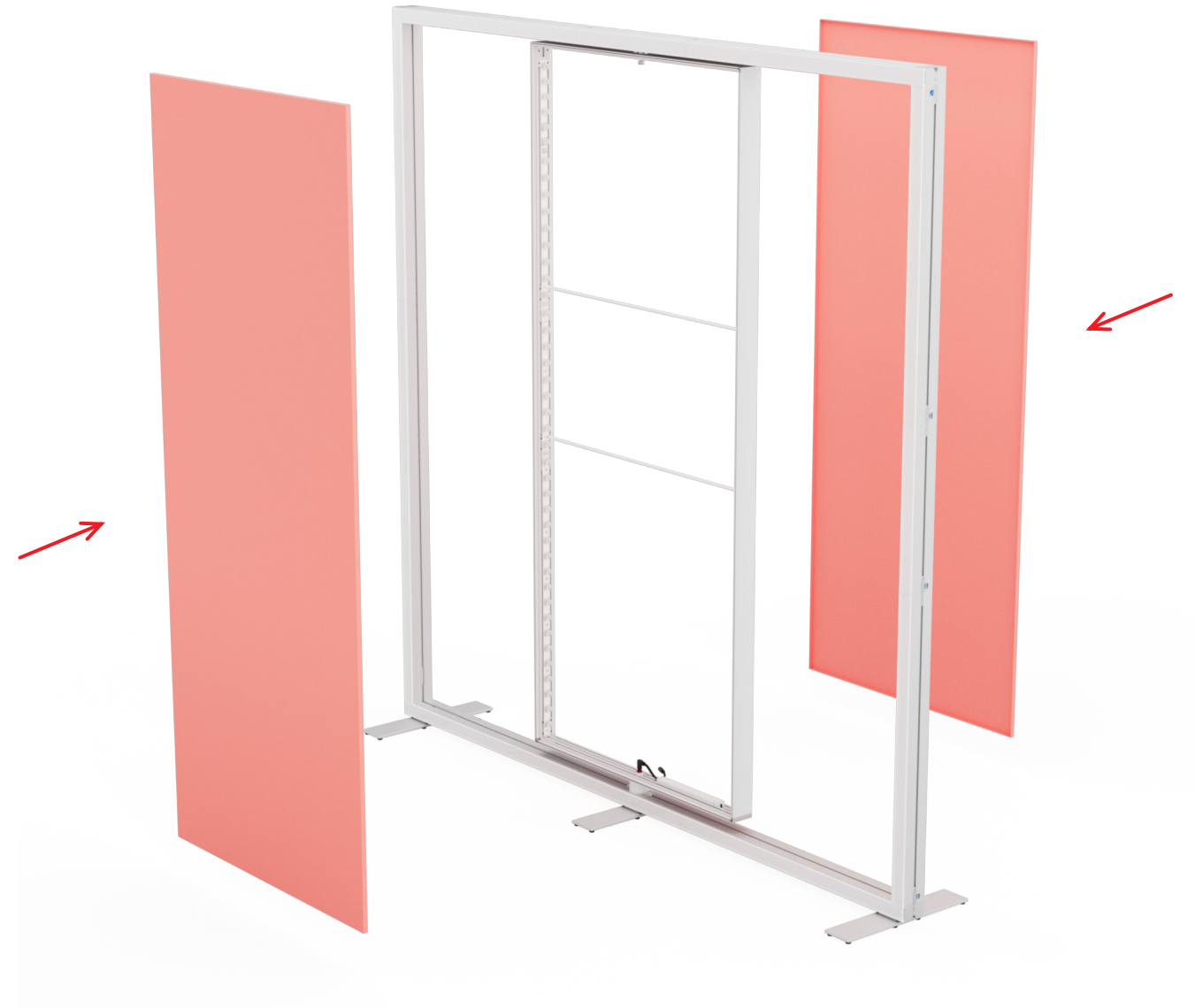

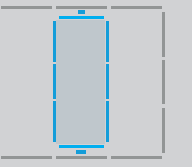
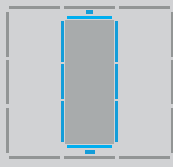

16.

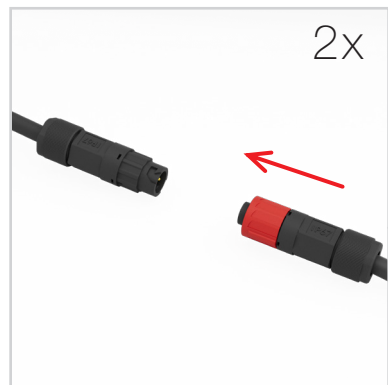

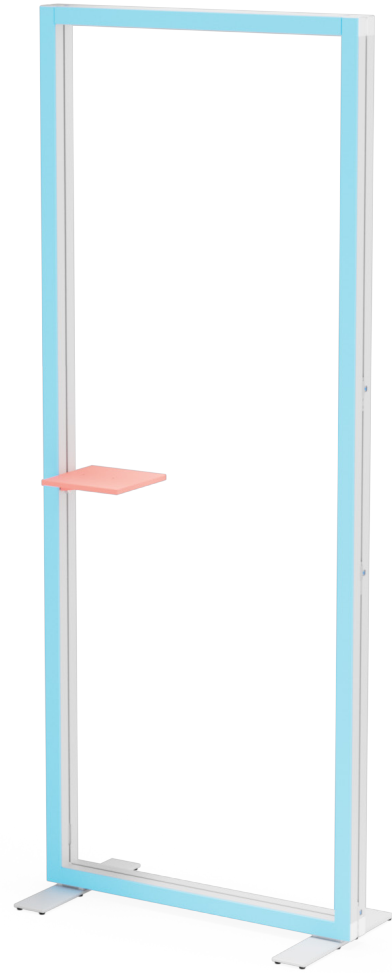
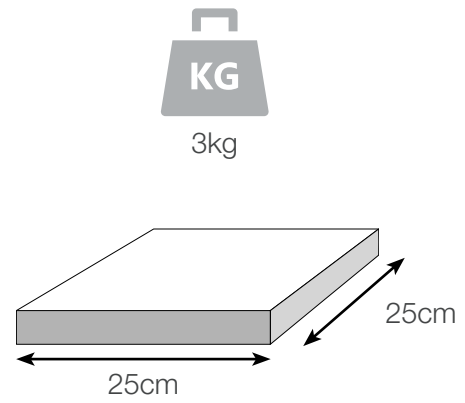

LINE-shelf-25-01





1.

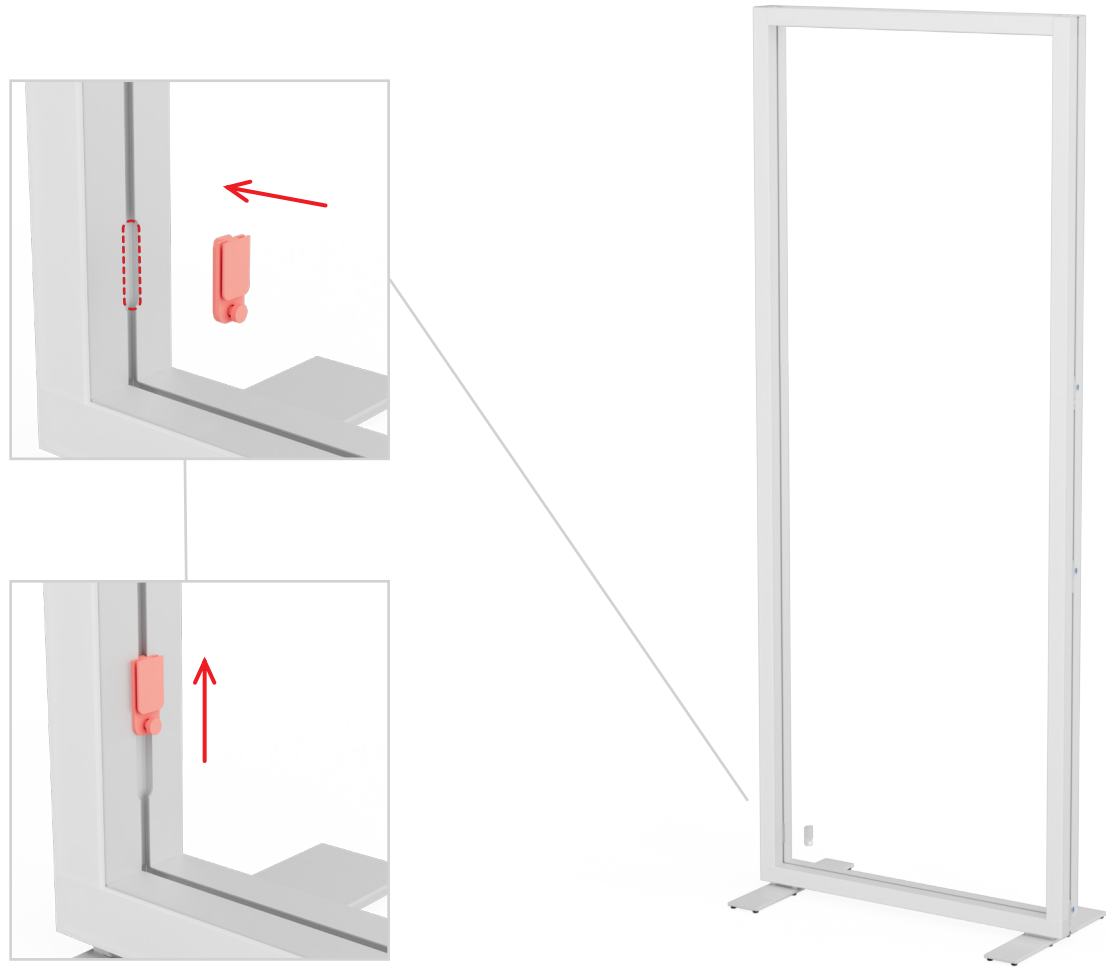

2.

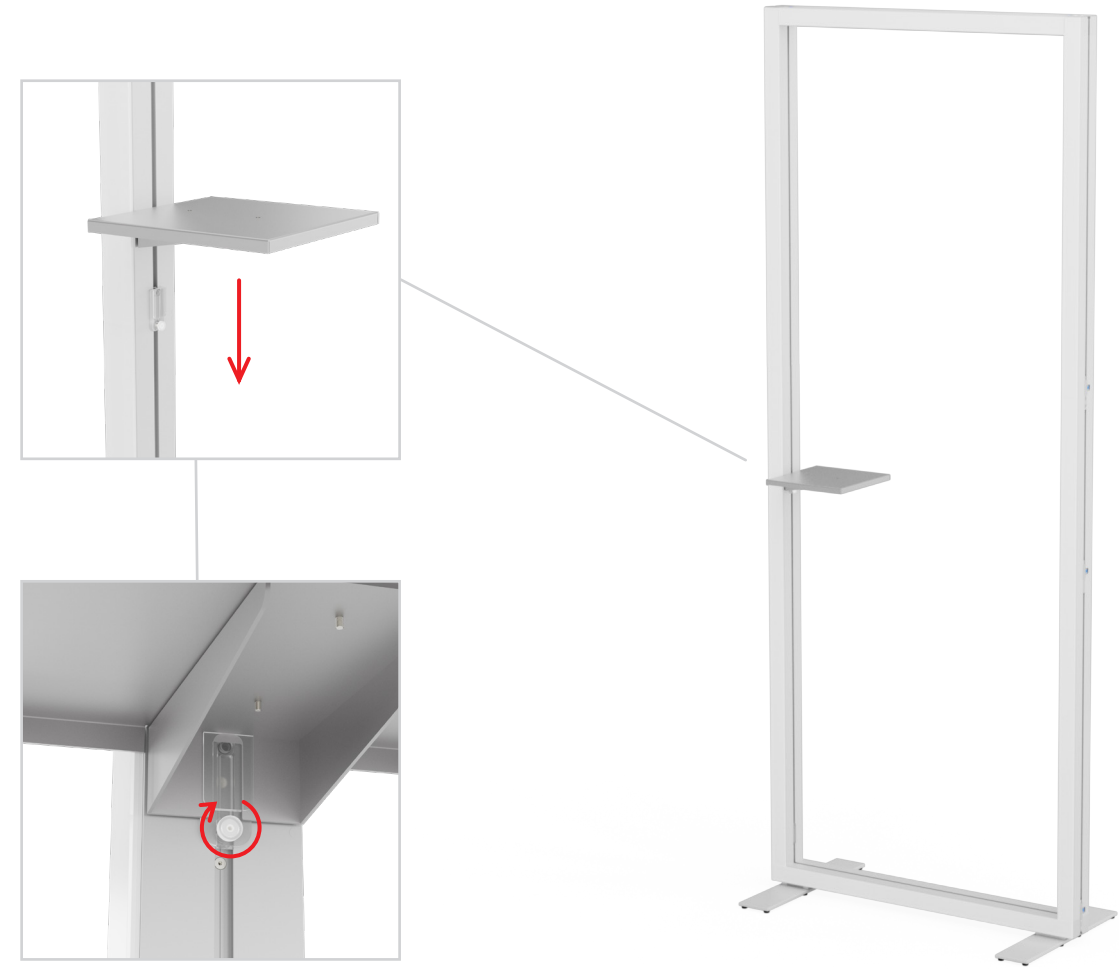

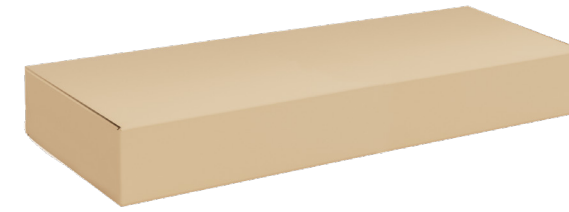
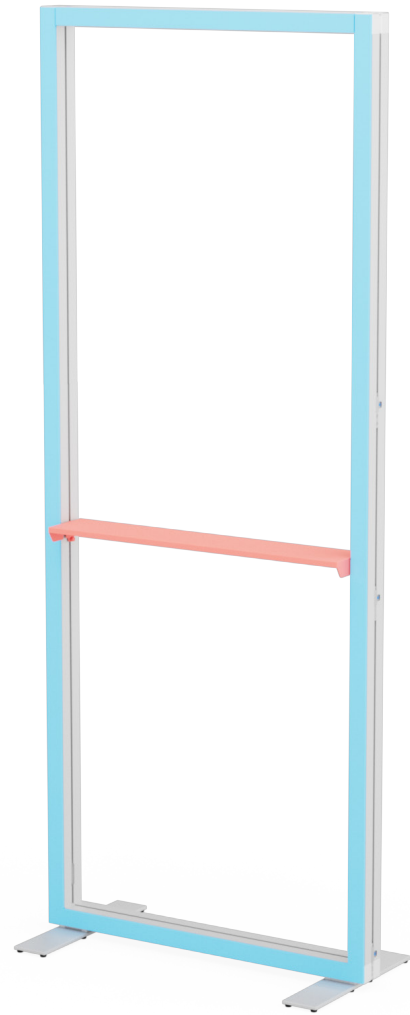
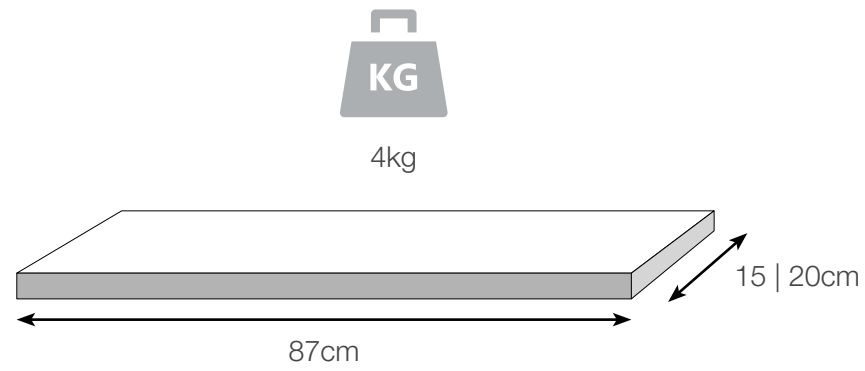

LINE-shelf-89-15 | 20

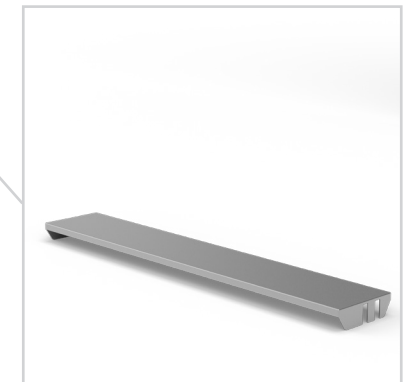



1.

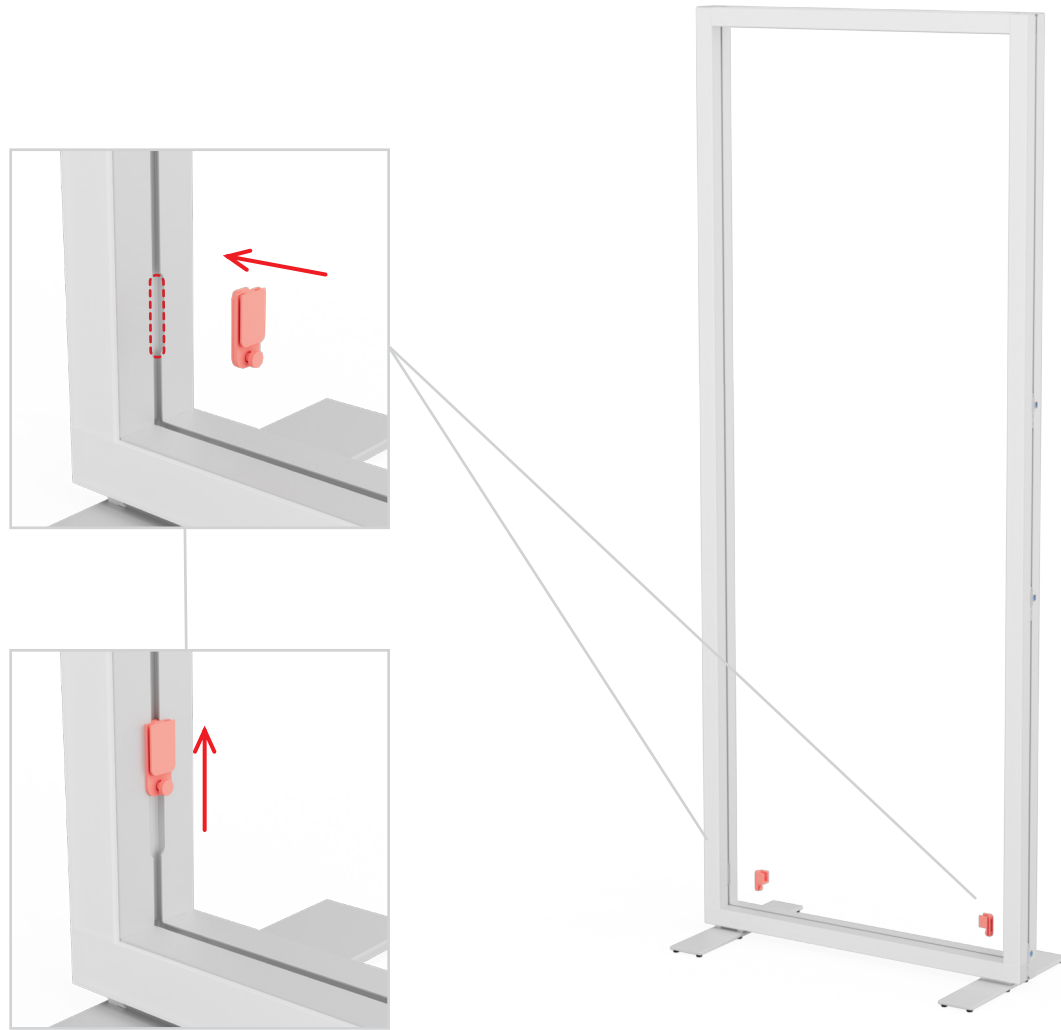

2.

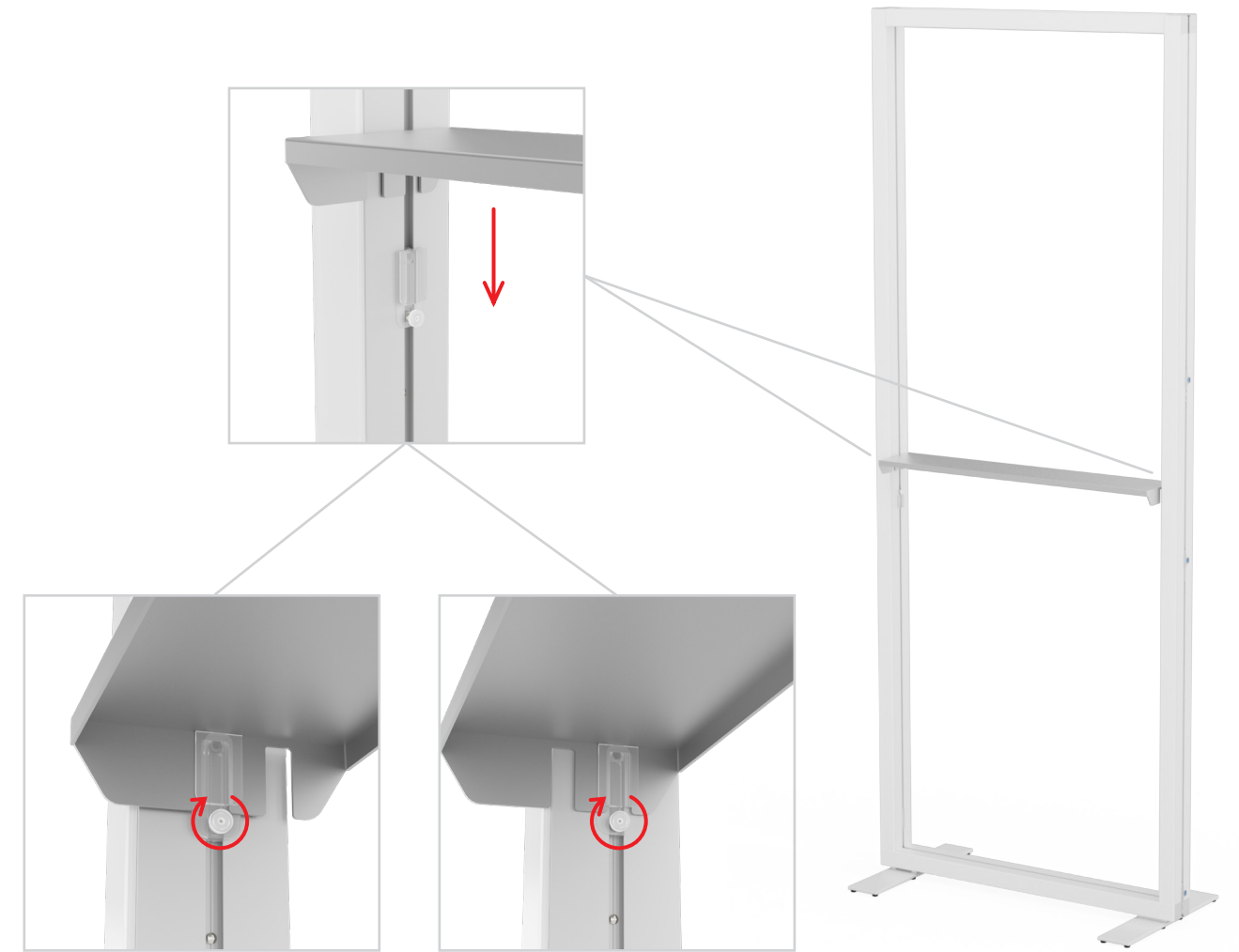

Option 1 middle
Option 1 Mitte

Option 2 front
Option 2 vorne

Backside print attachment possible
Stoffbespannung hinten möglich

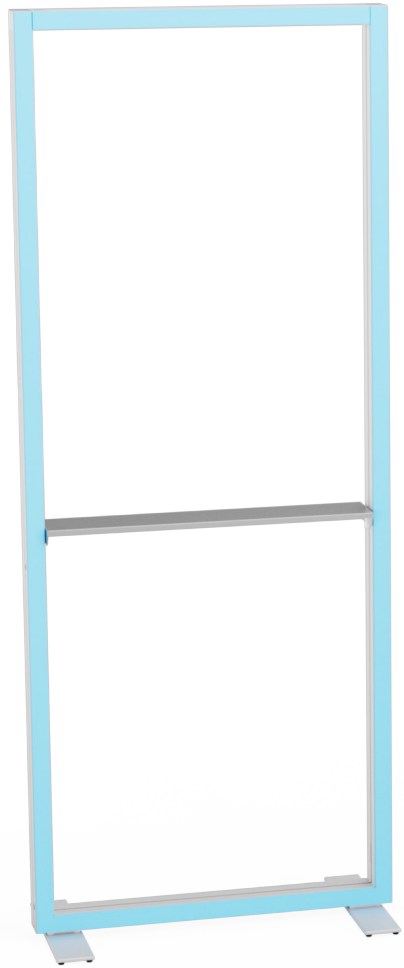
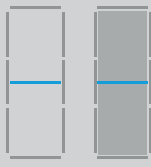

Option 1 middle
Option 1 Mitte

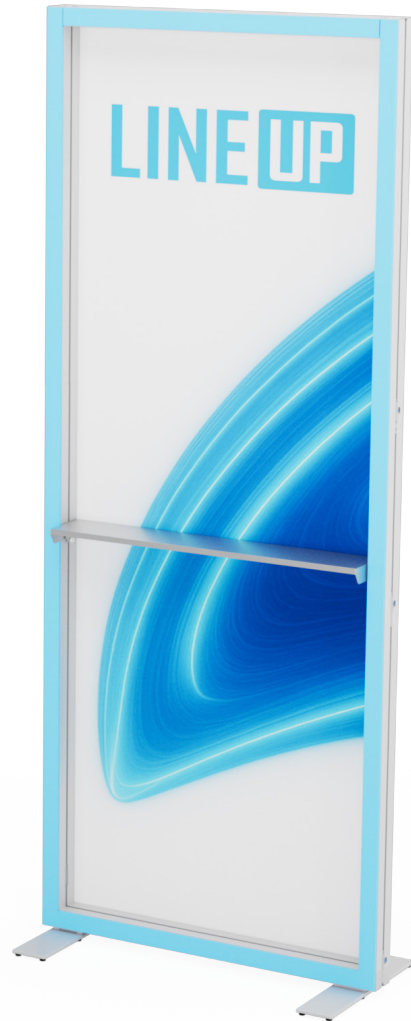

Option 2 front
Option 2 vorne

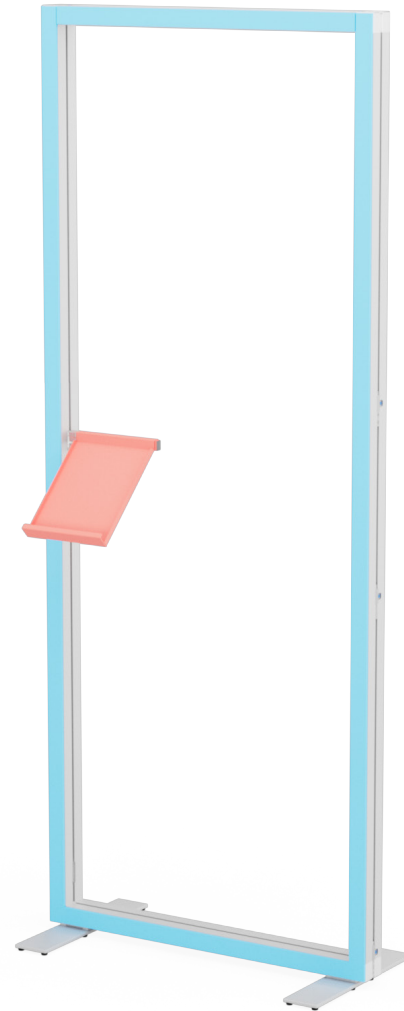
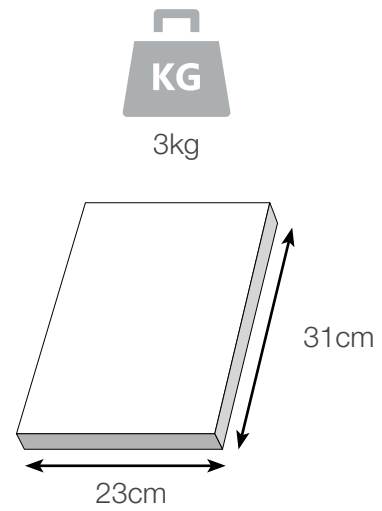



1.

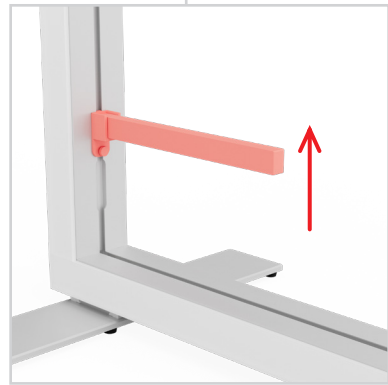
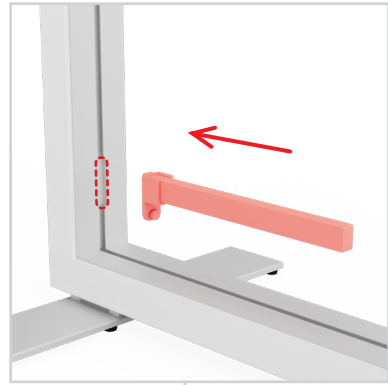

2.

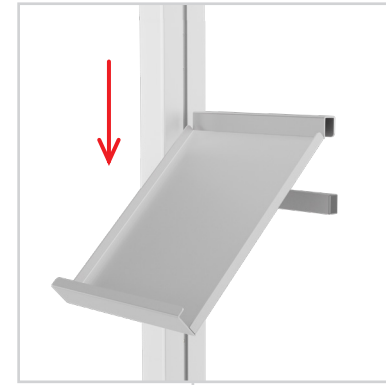

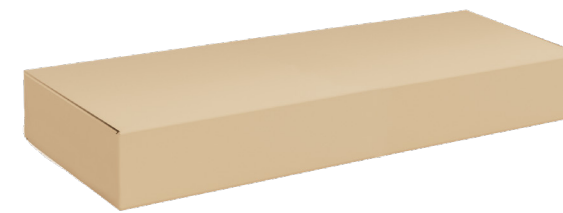
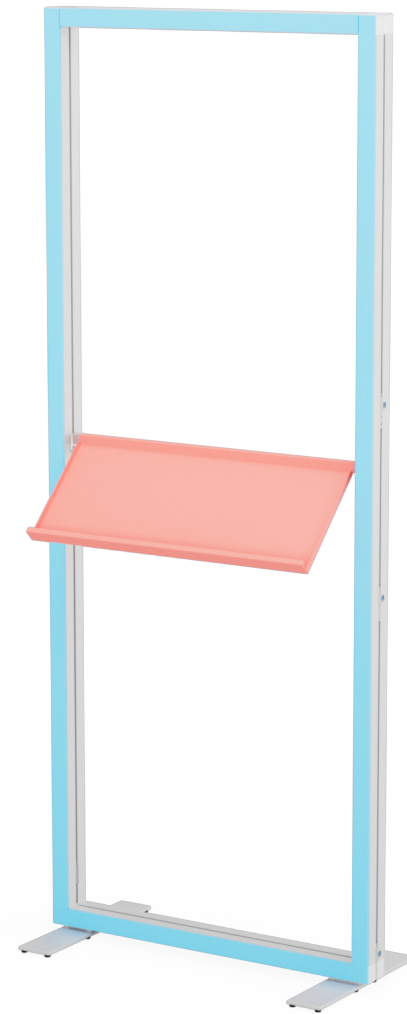
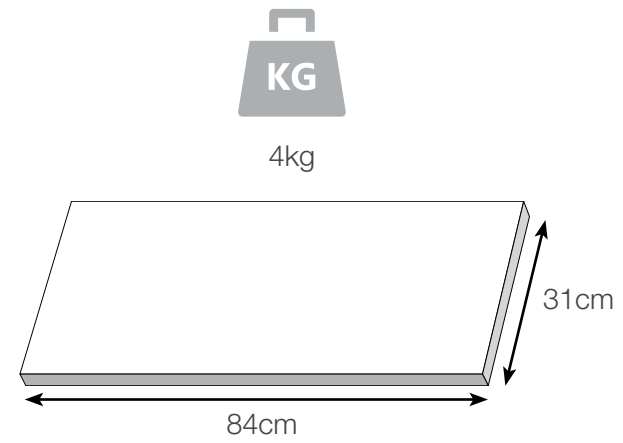

LINE-brochure-84-01

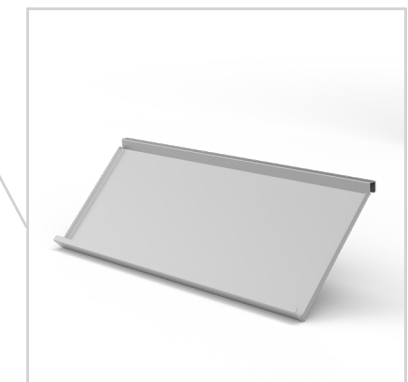
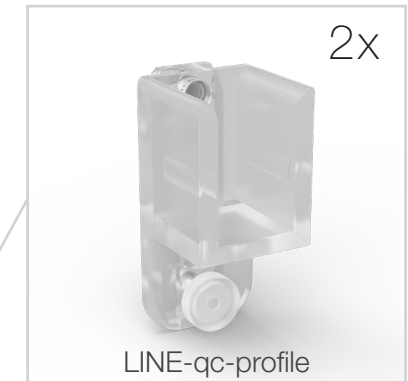



1.

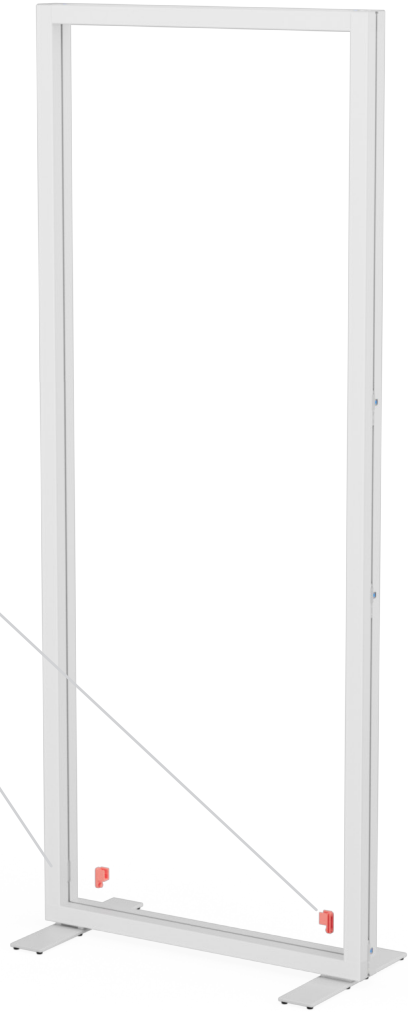
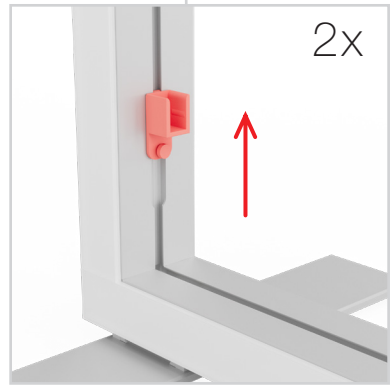
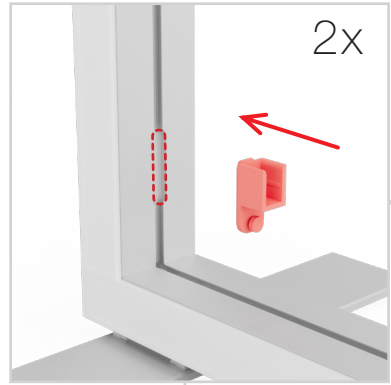

2.

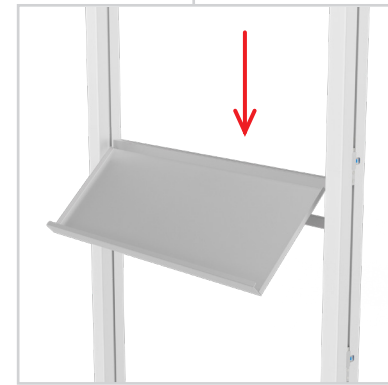
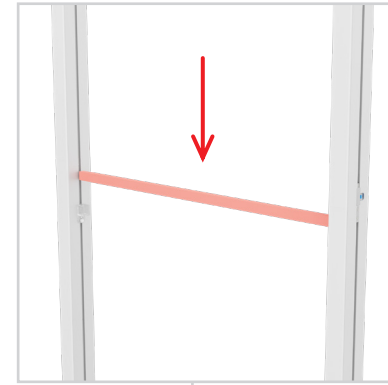

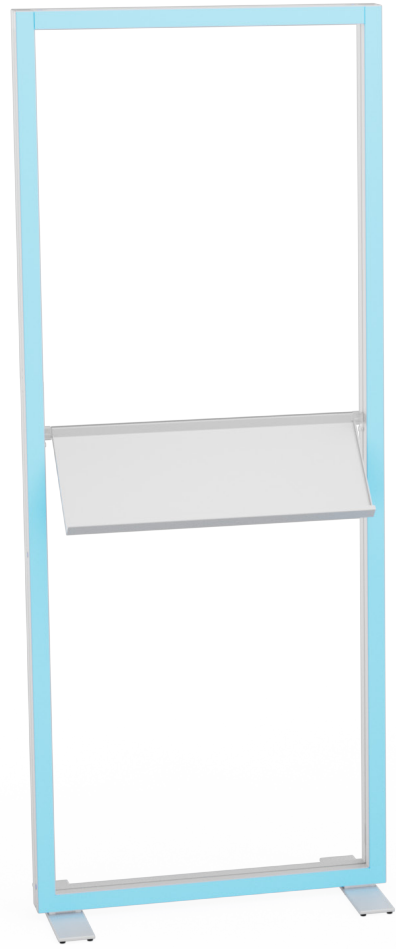
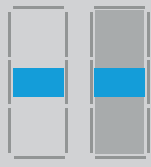

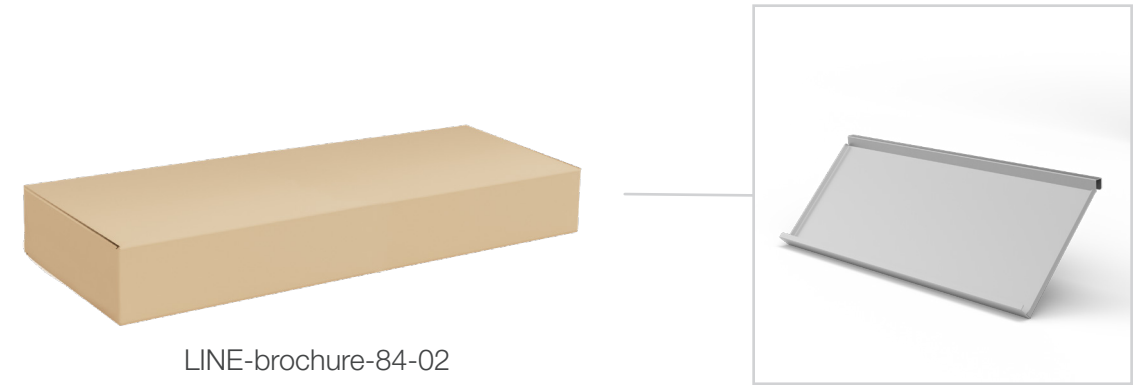
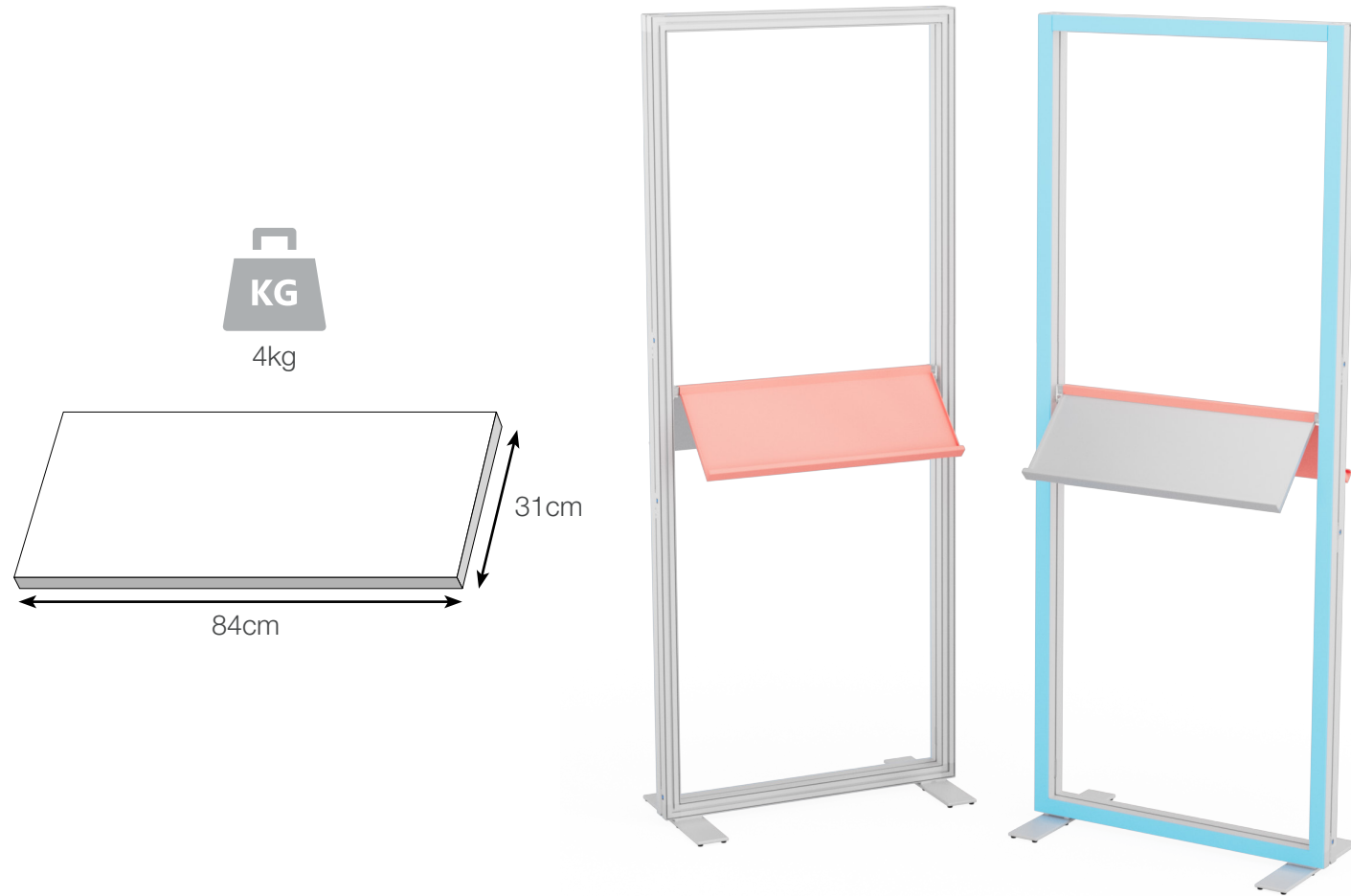

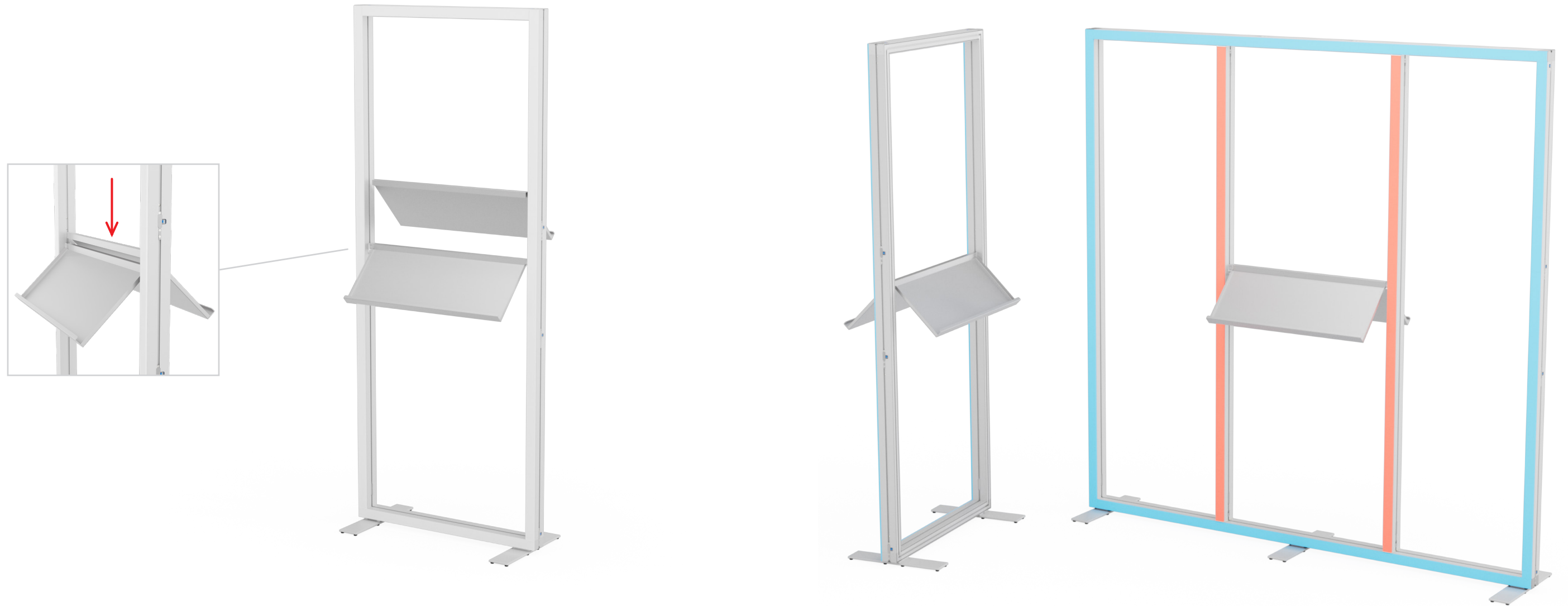
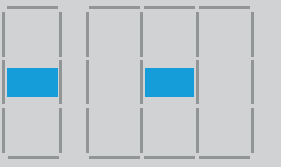

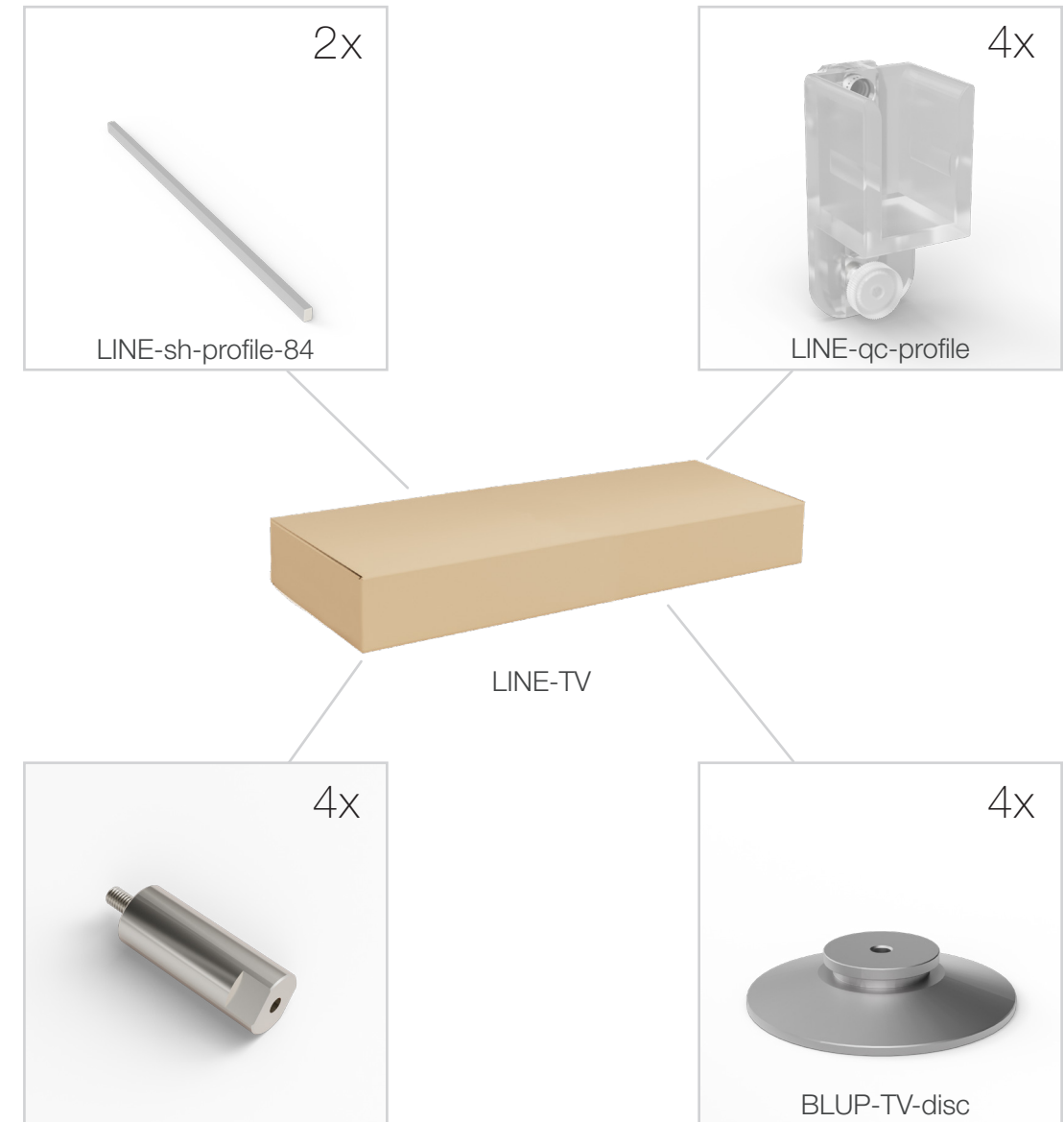
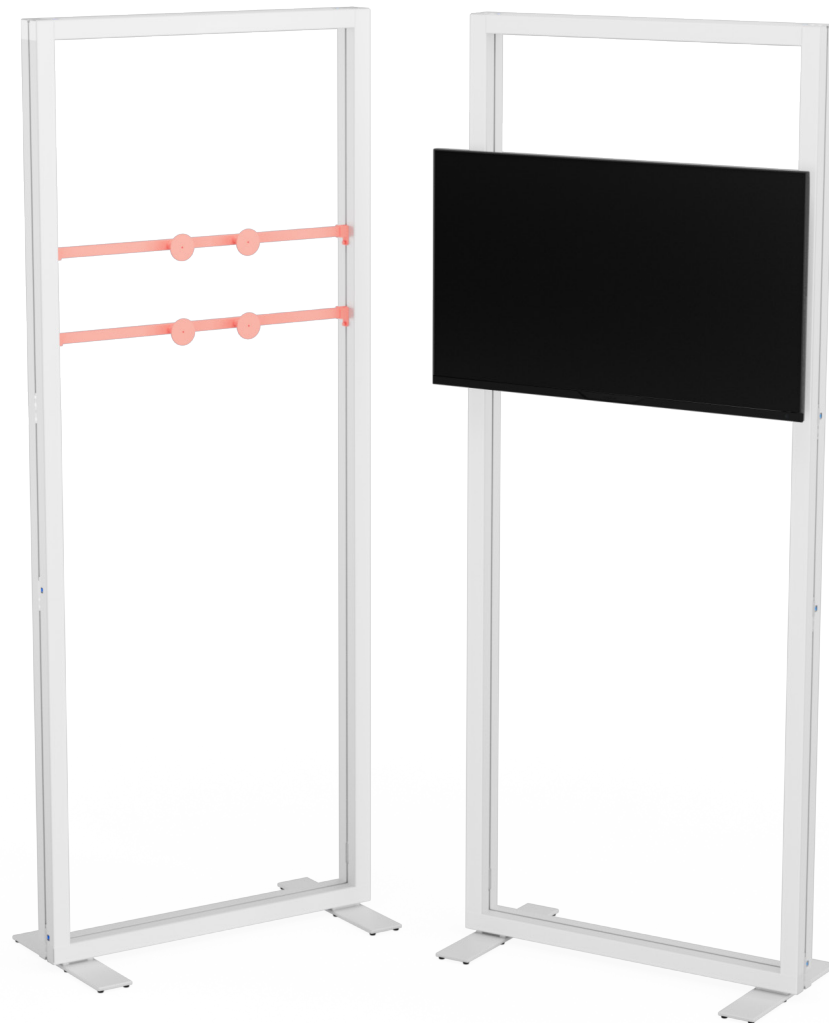



Option A

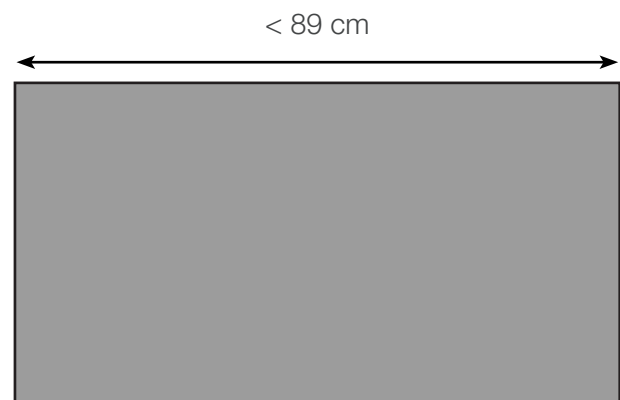

TV width max. 89 cm
TV Breite max. 89 cm



skip to page 106
Seite 106

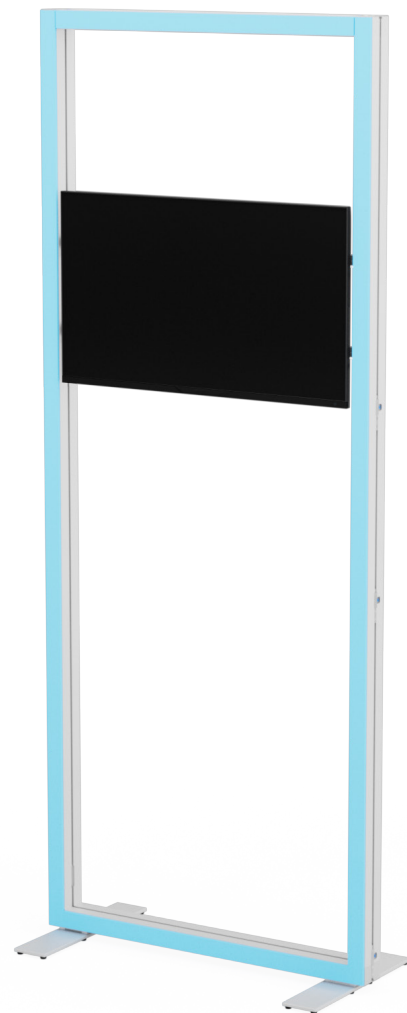

Option B

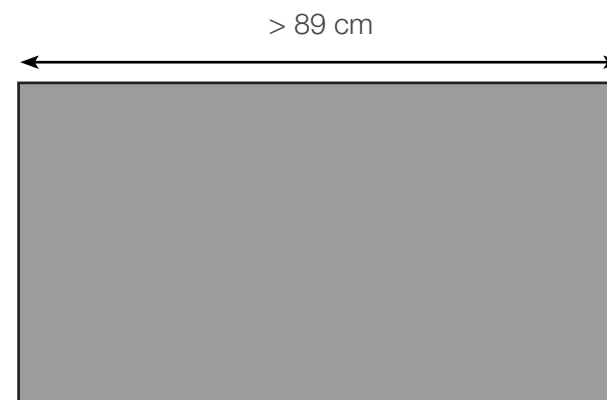

TV width from 89 cm
TV Breite ab 89 cm

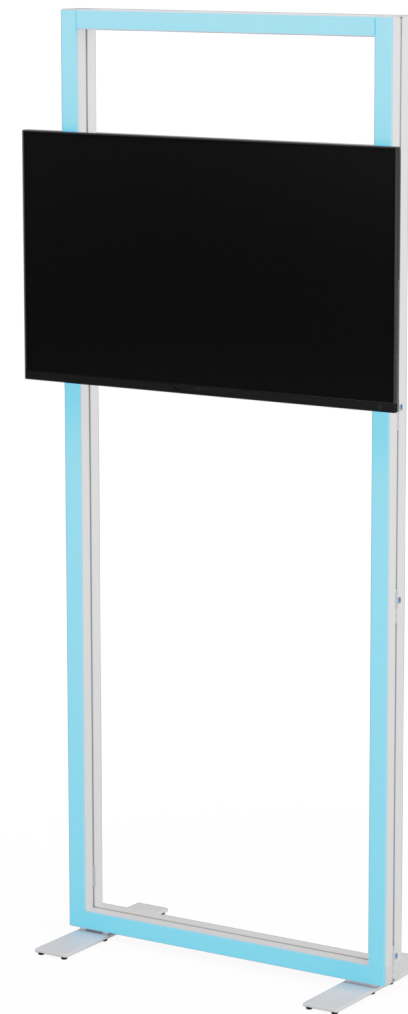



Option B

1.

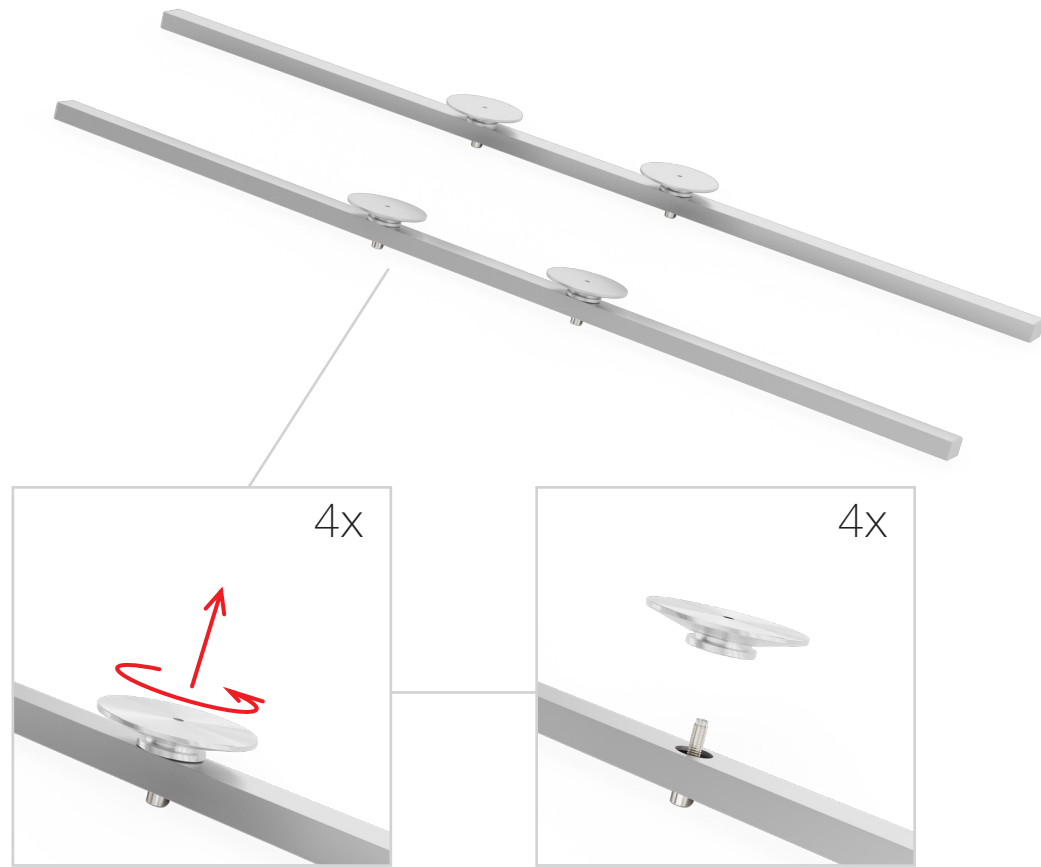

Option B

2.

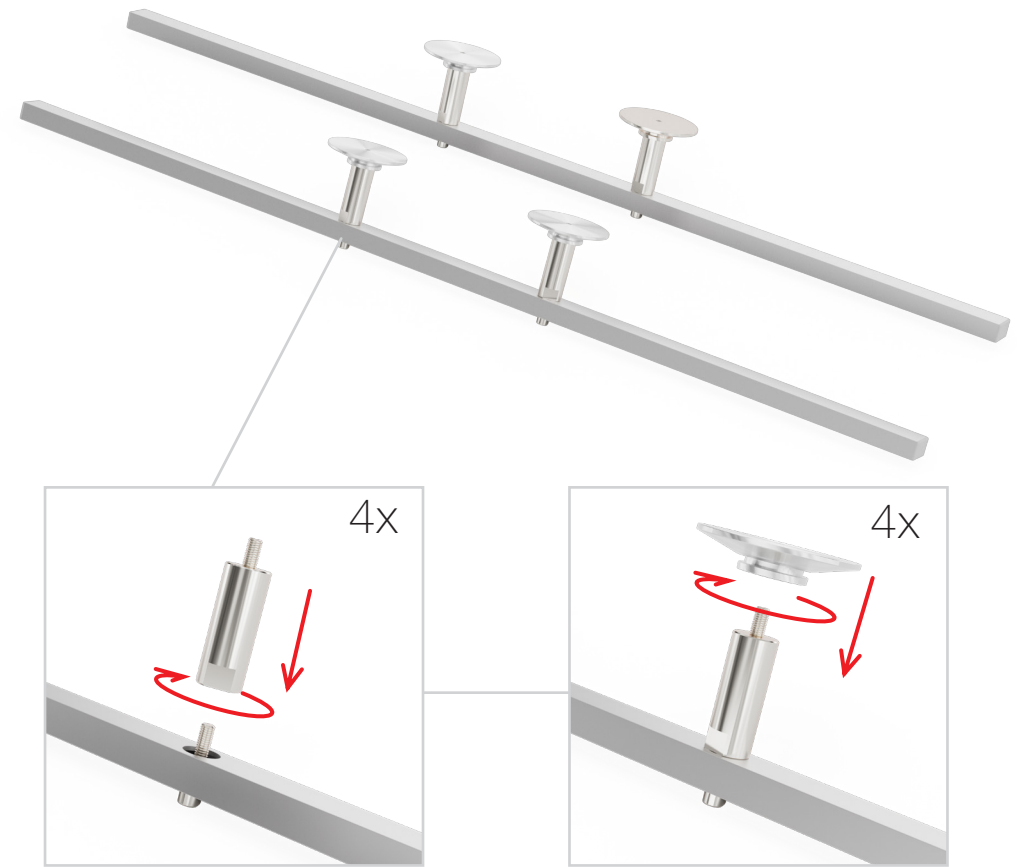



Option A+B

3.

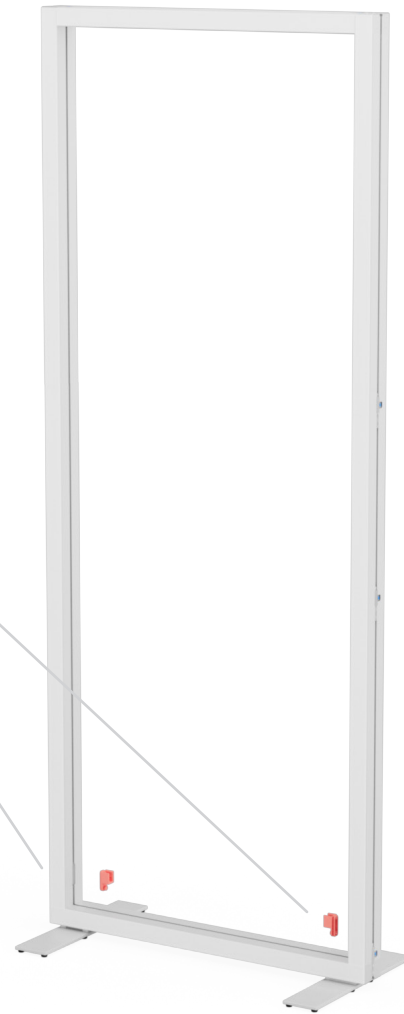
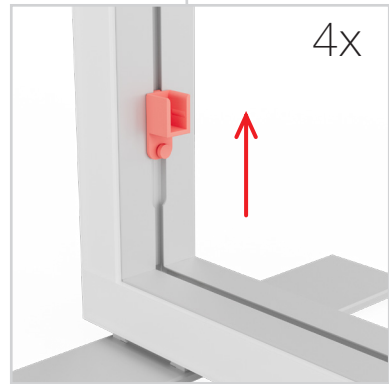
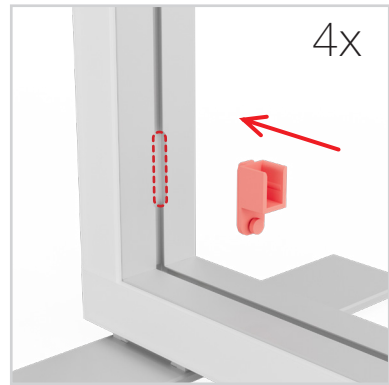

4.

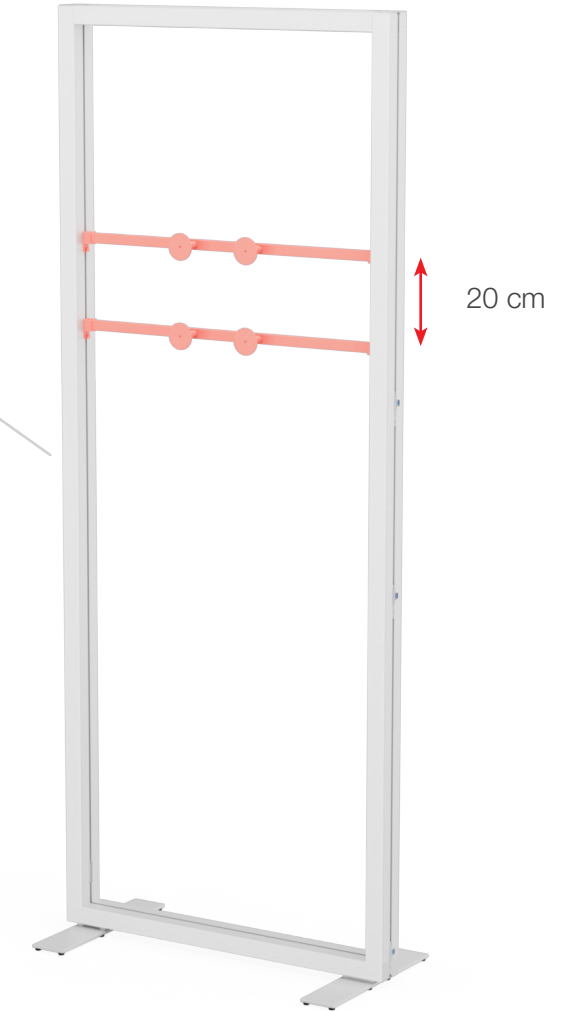
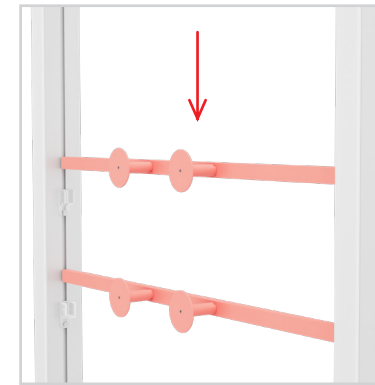
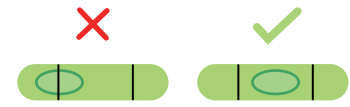



5.

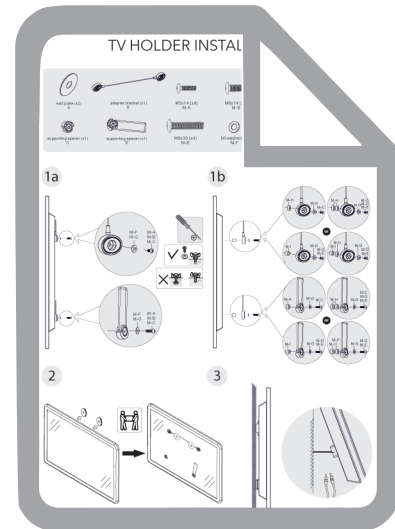

6.

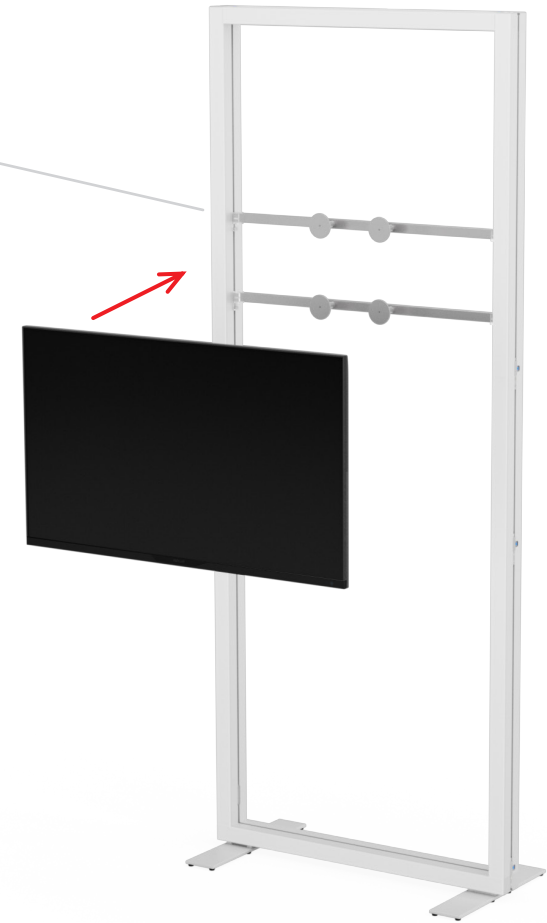
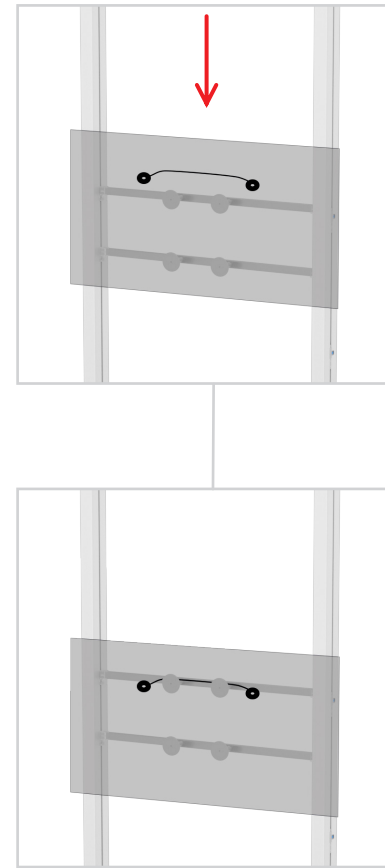

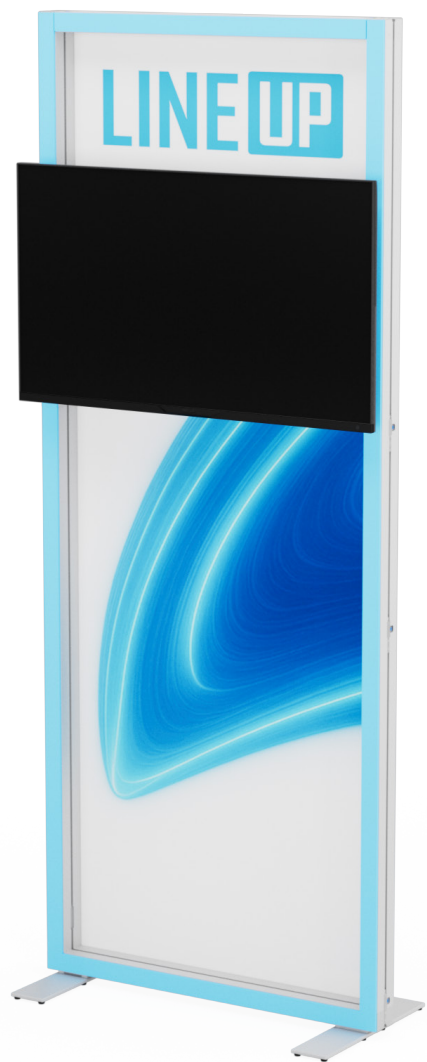

bungee cord
Expanderseil
20m

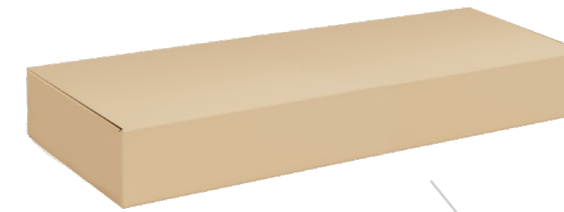
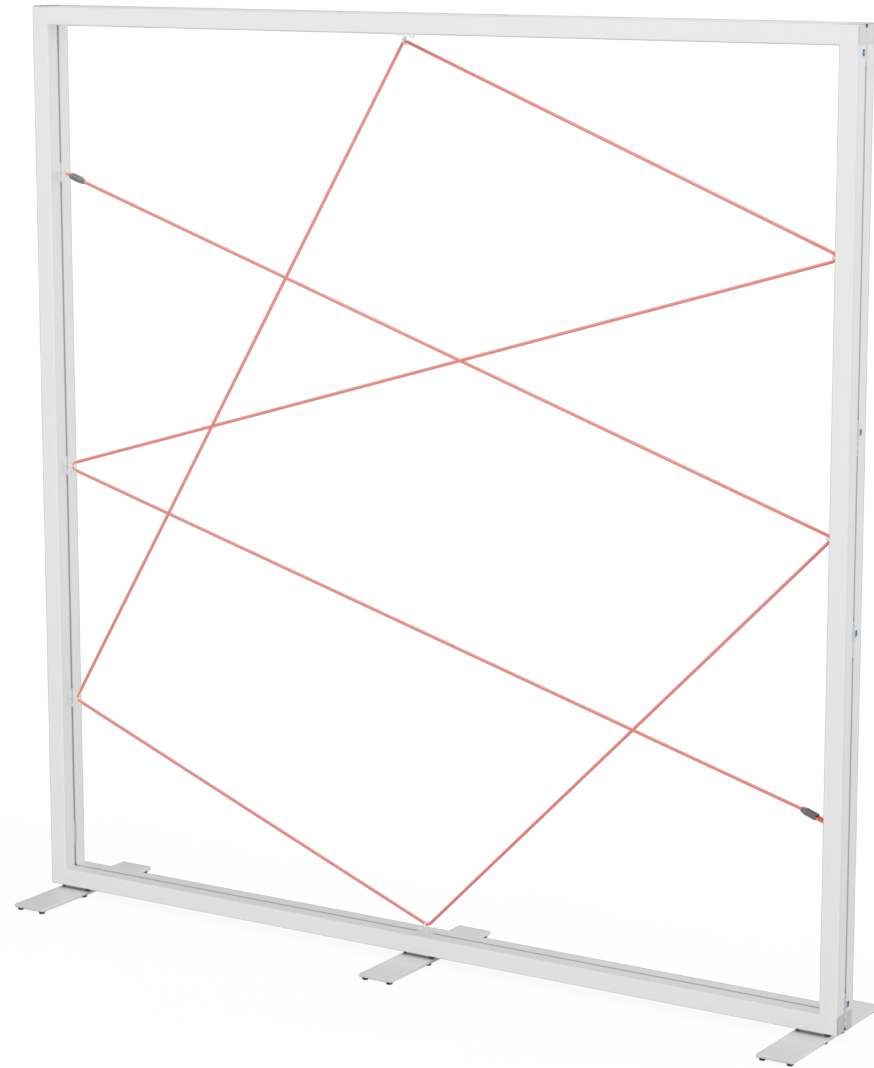

LINE-b-coard

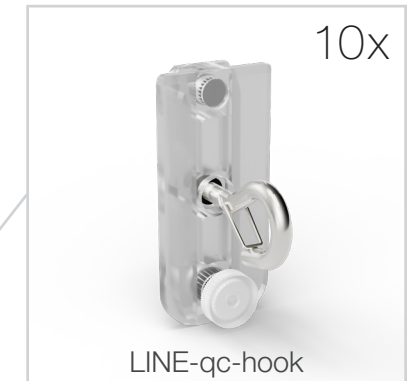

LINE-qc-hook



pre-installed
vorinstalliert

2x

BLUP-b-coard-holder

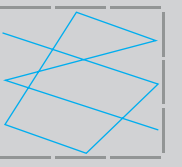
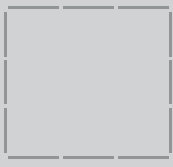

1.

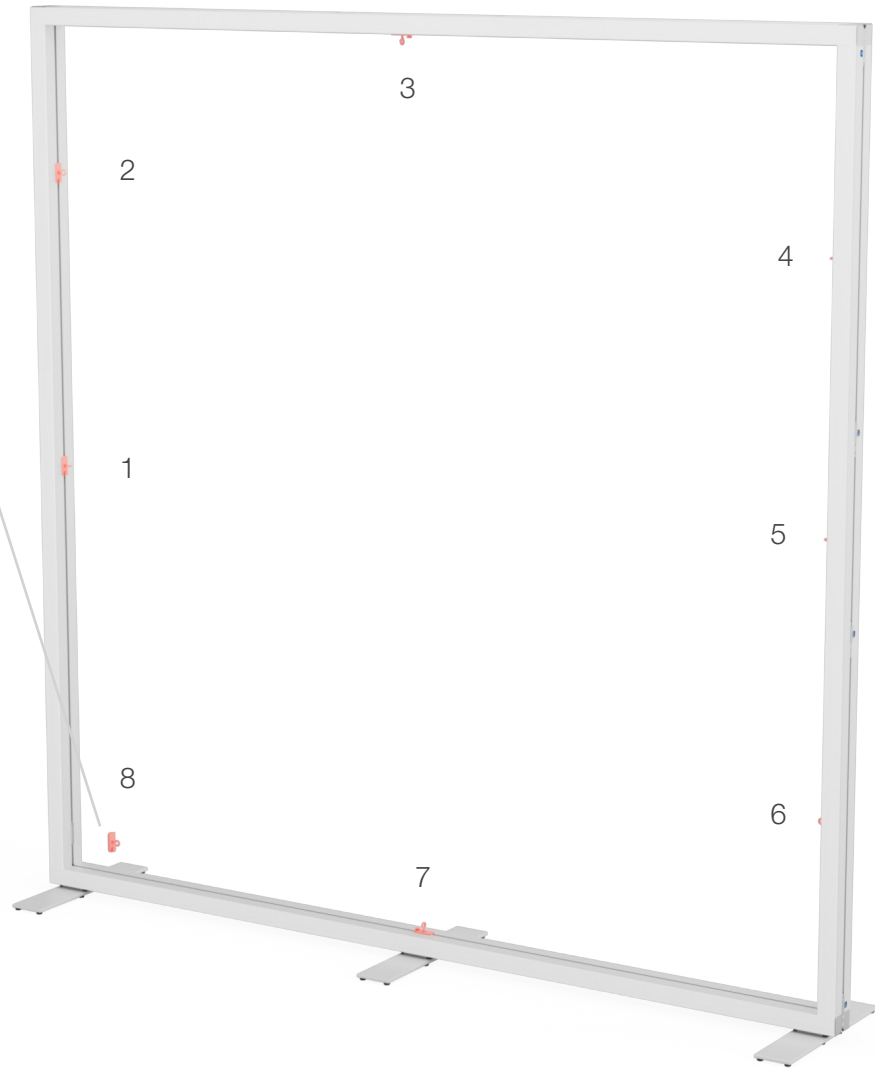
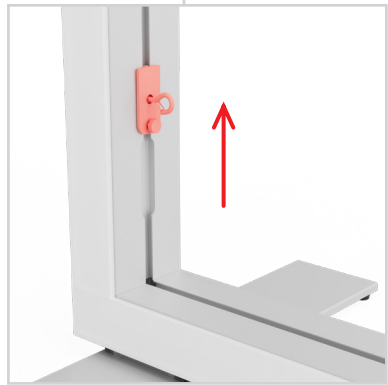
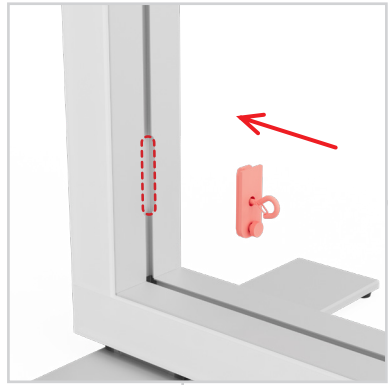

2.

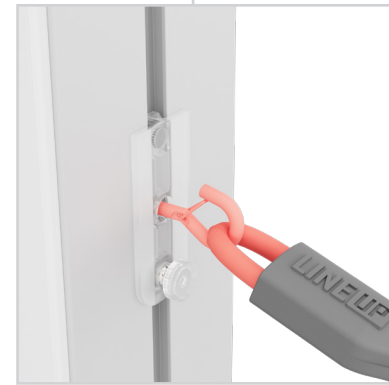

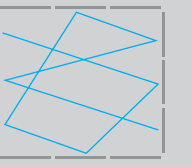
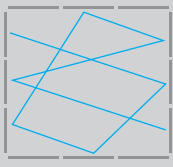

3.

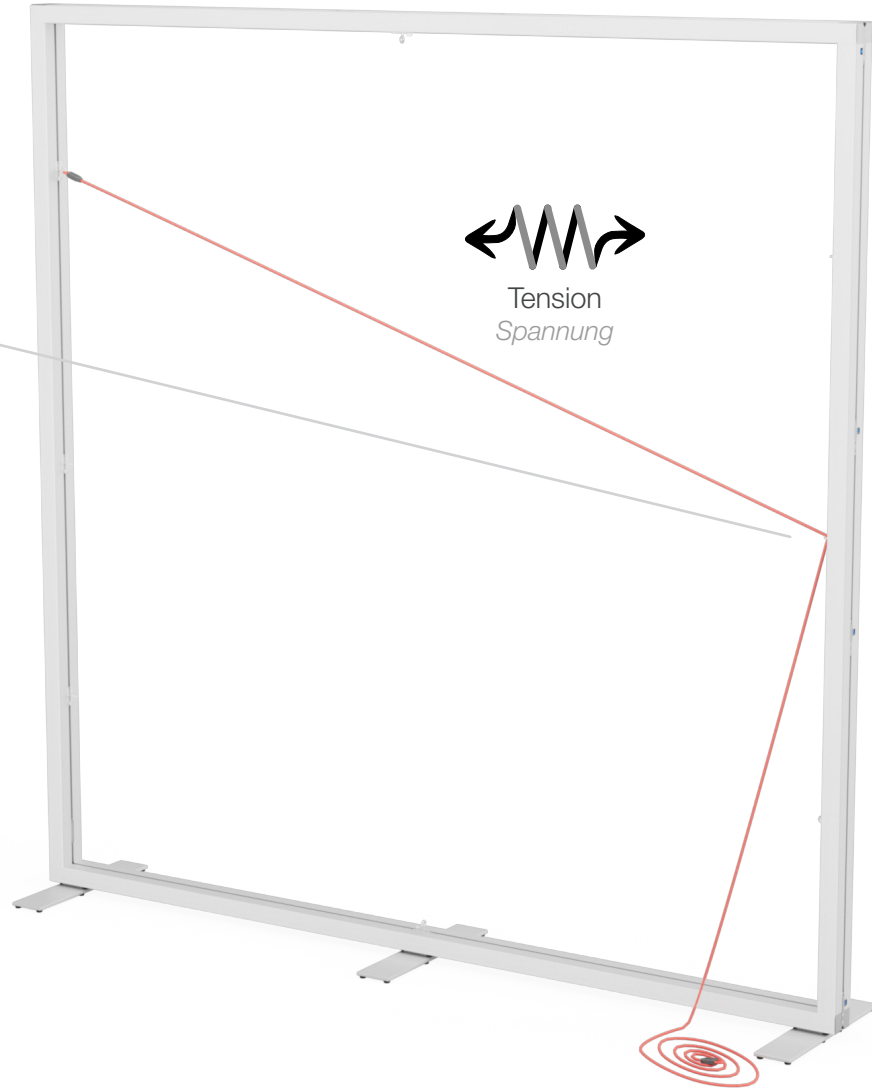
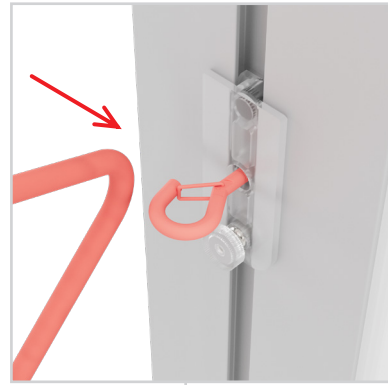

4.

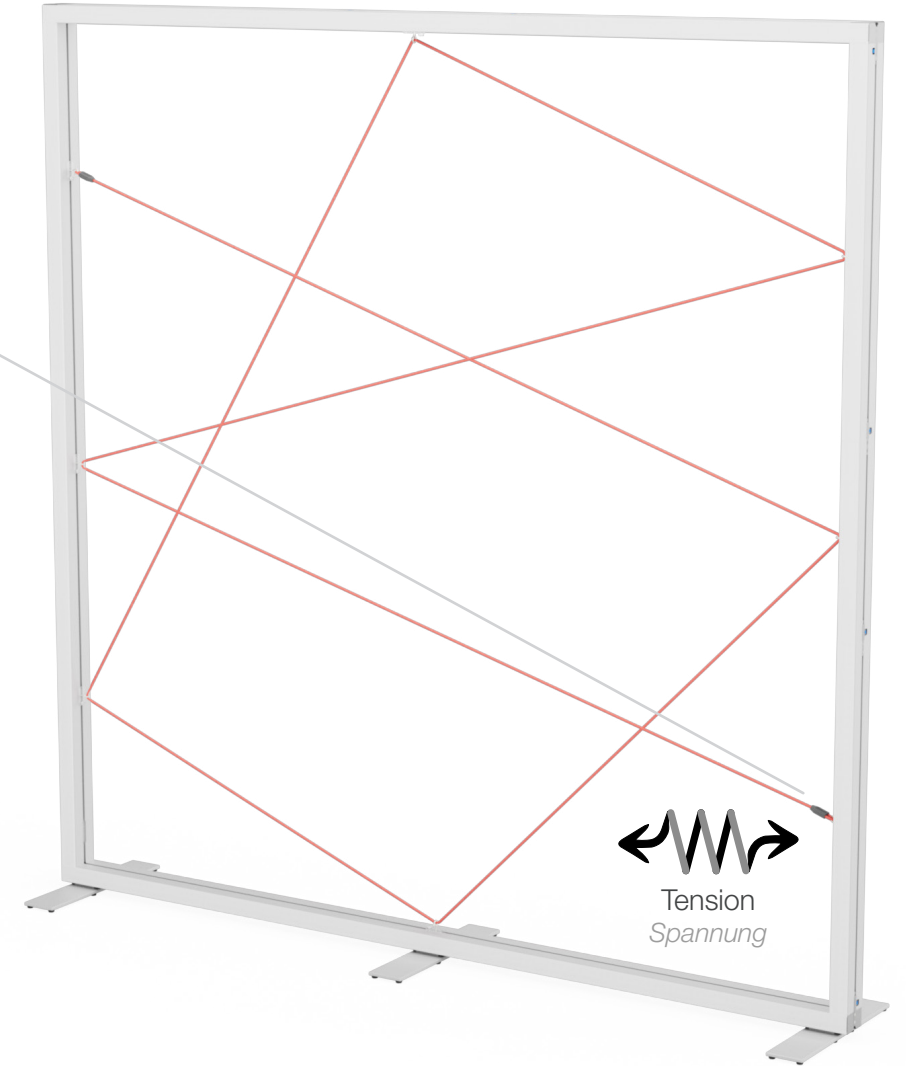

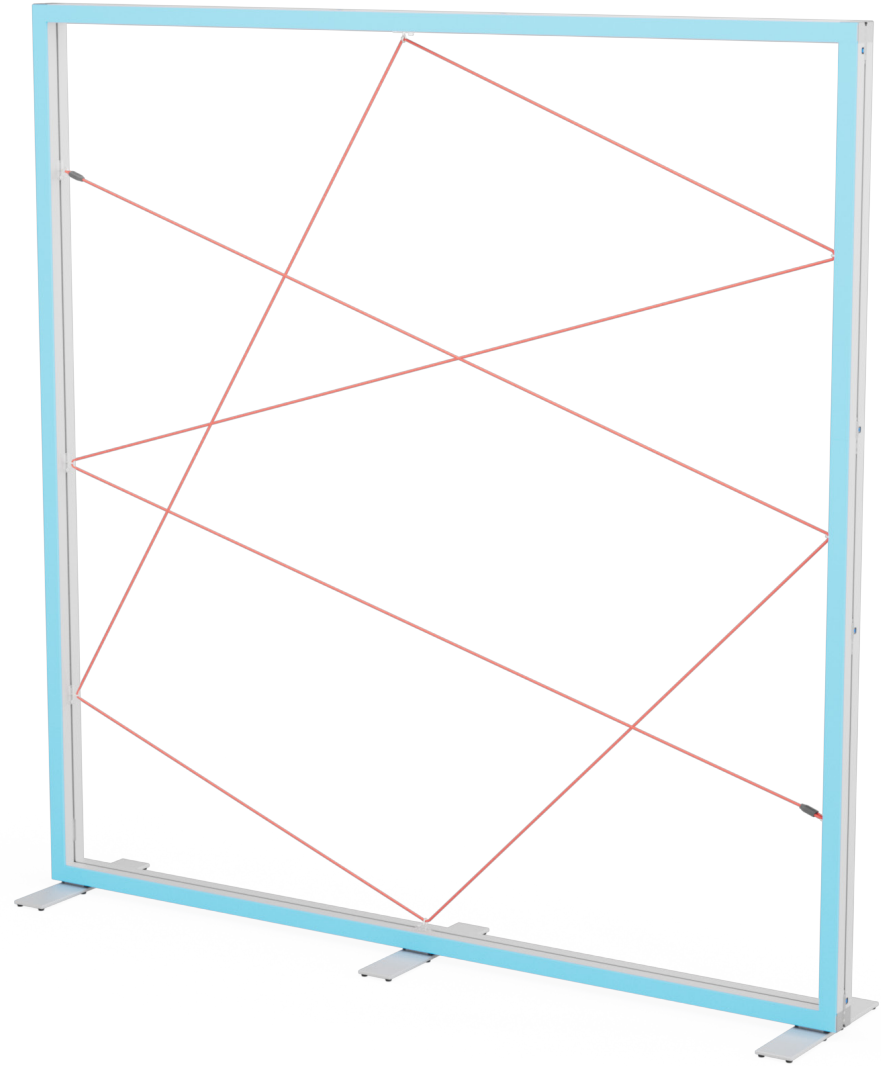
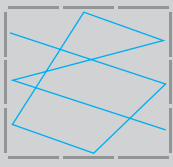

bungee cord shorten
Expanderseil kürzen

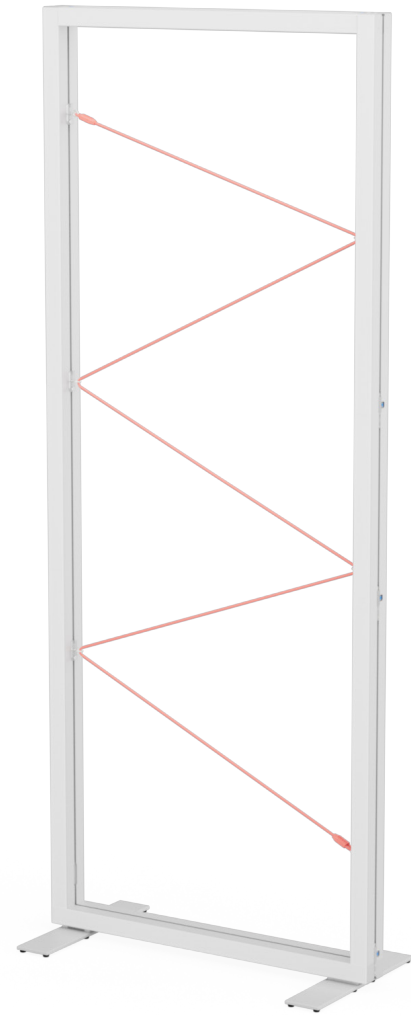

1.

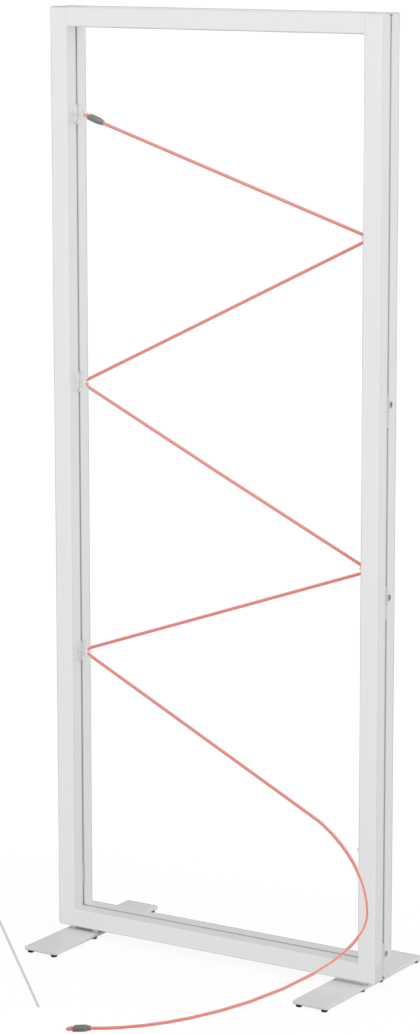
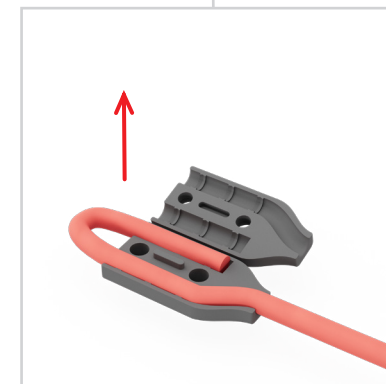
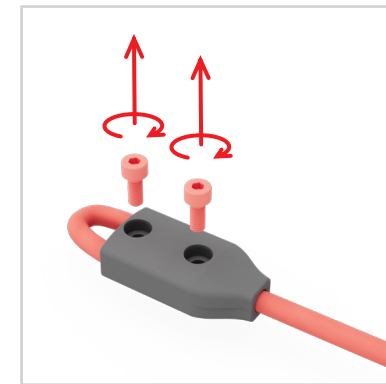



2.

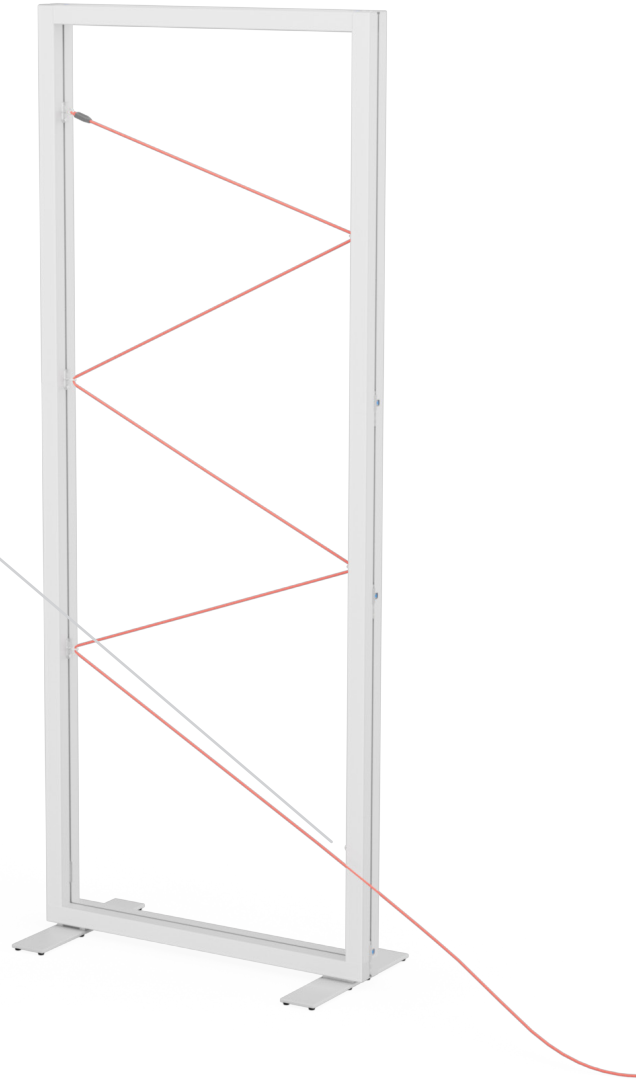
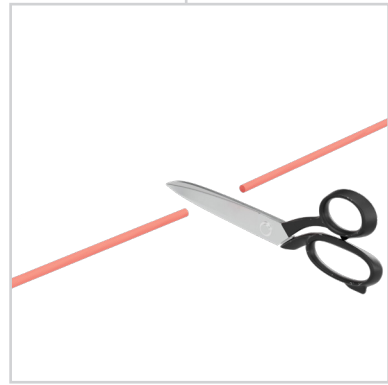
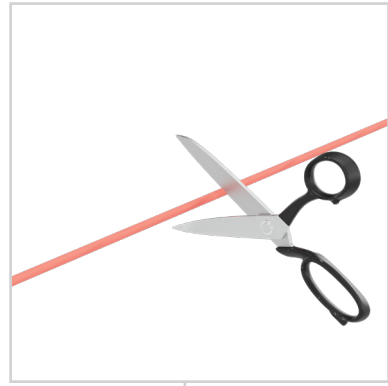

3.

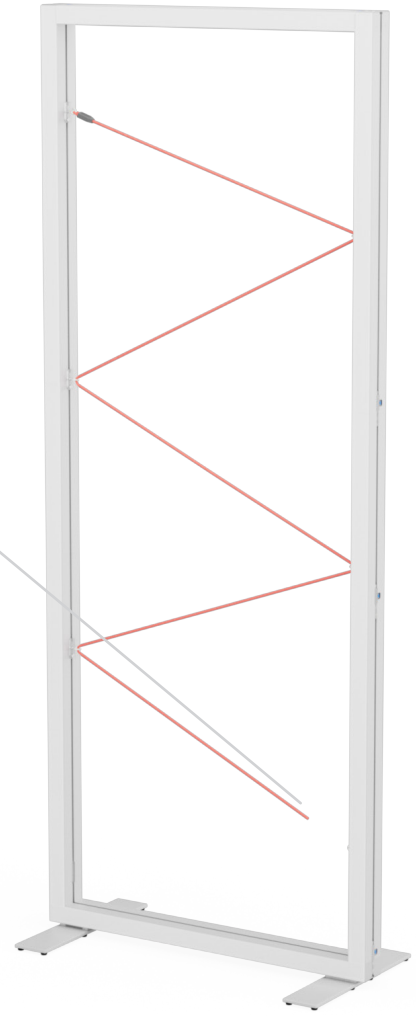
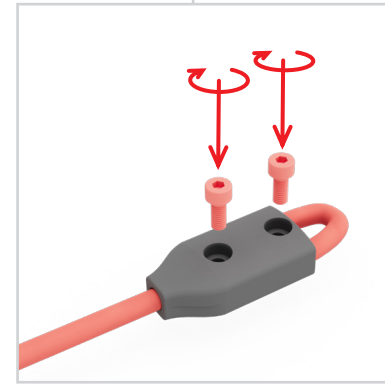
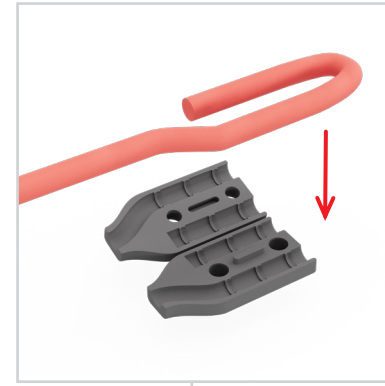

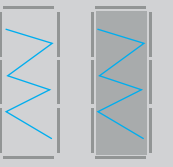

4.

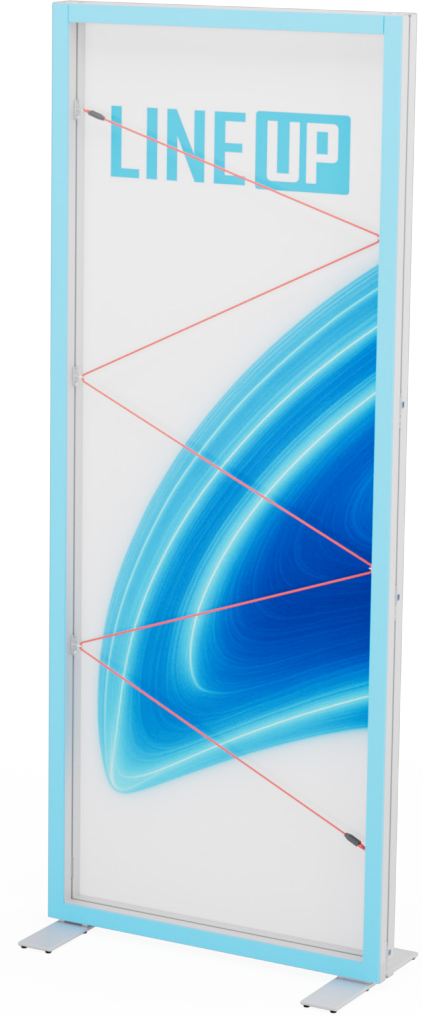
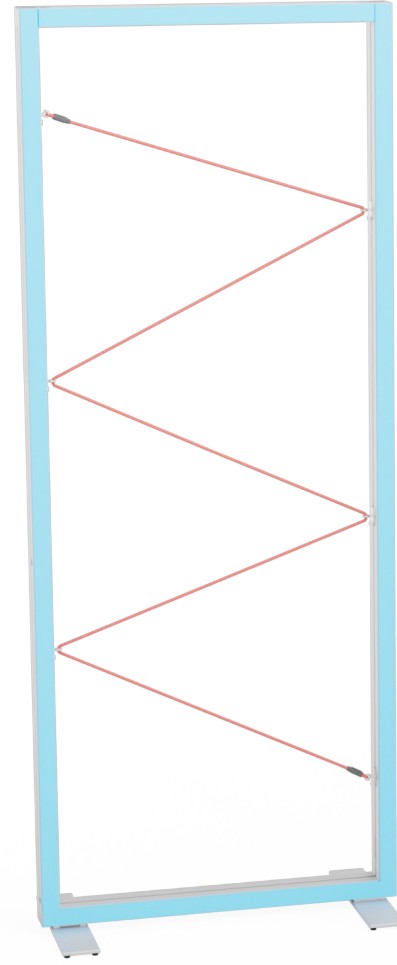
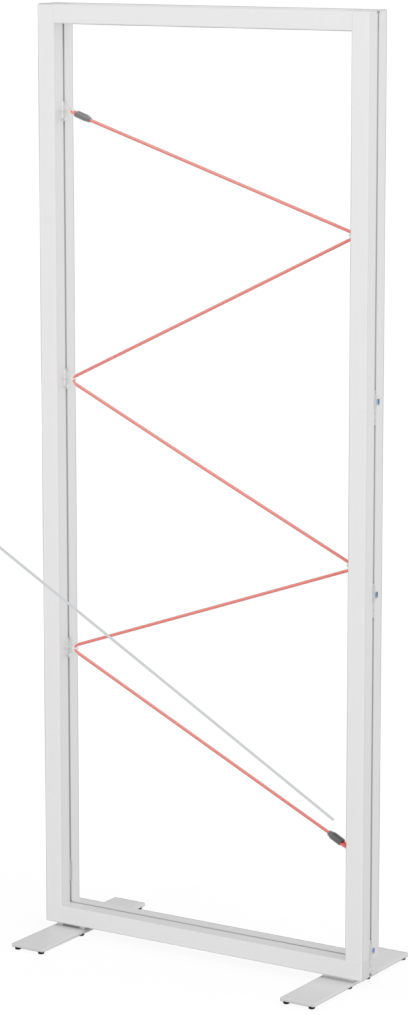



Product hanger
Produkhänger



LINE-ph-300

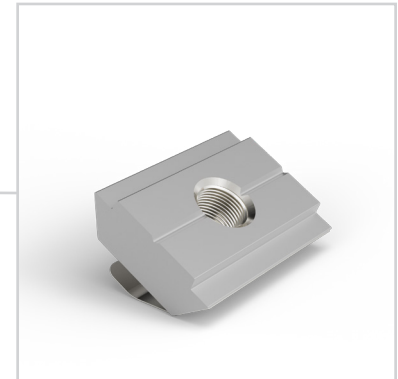



1.

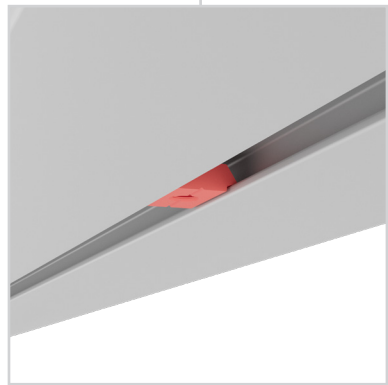
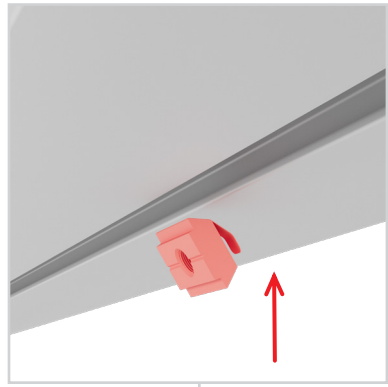

2.

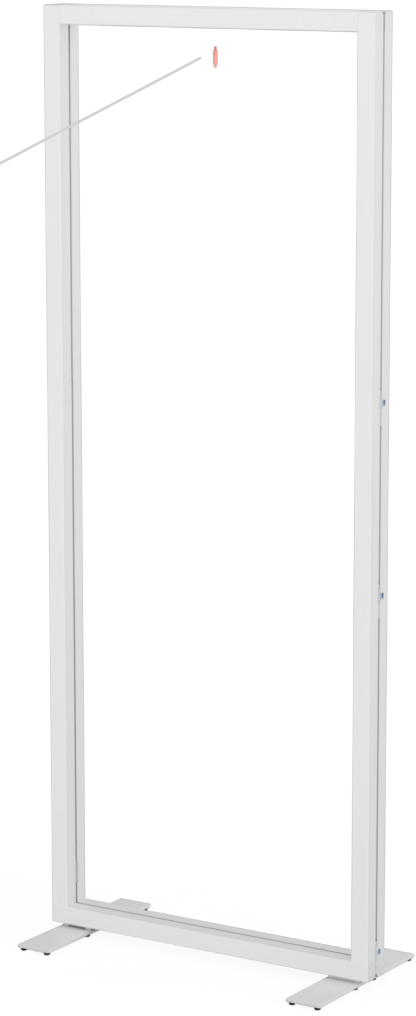
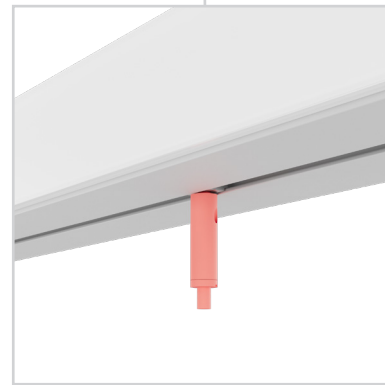
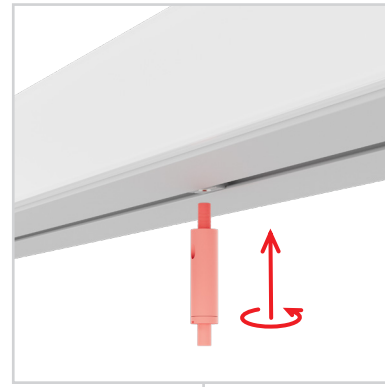



3.

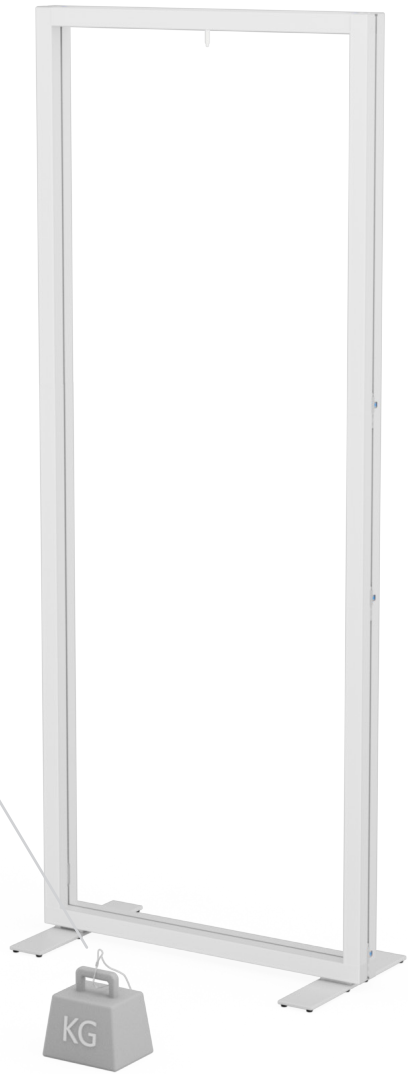
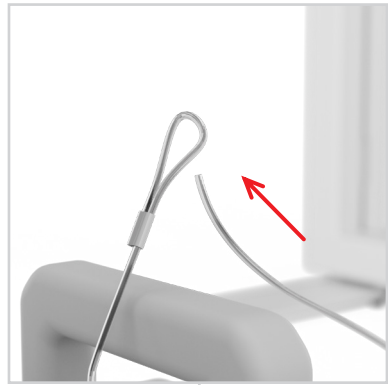

4.

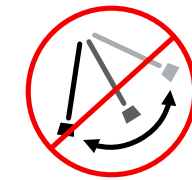
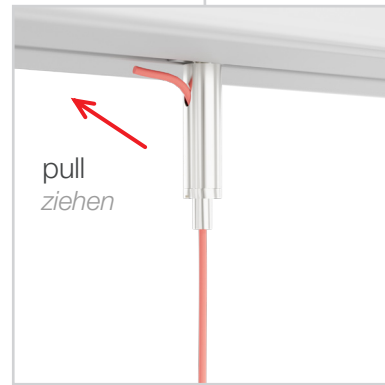
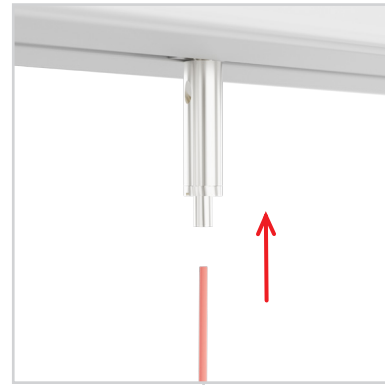

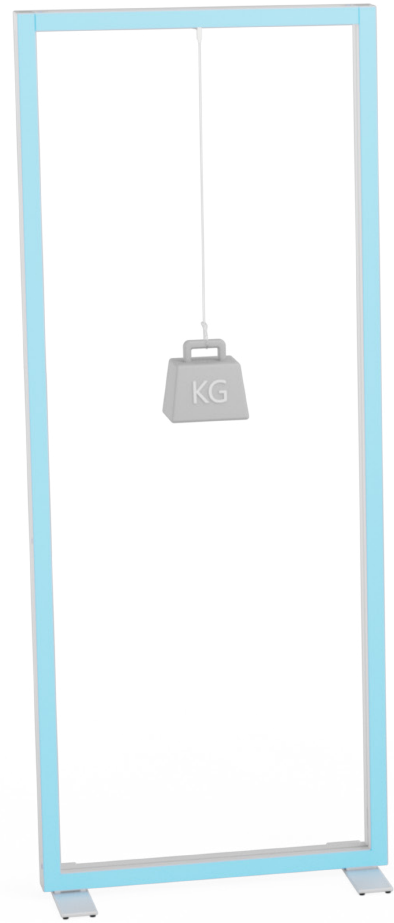
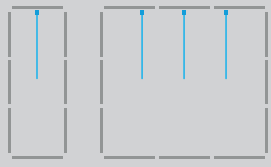

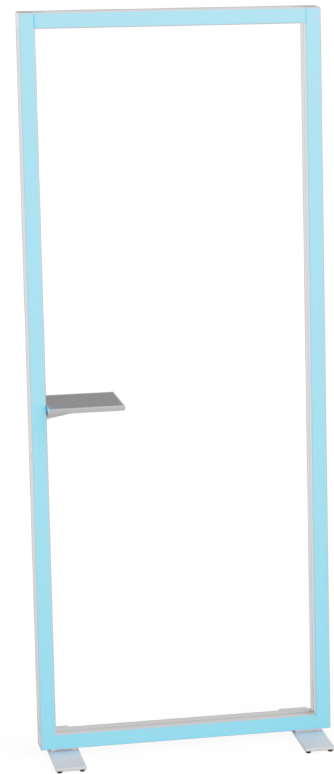
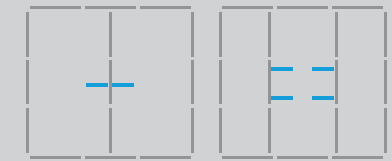

-LINE-stele-100-300
-LINE-shelf-25

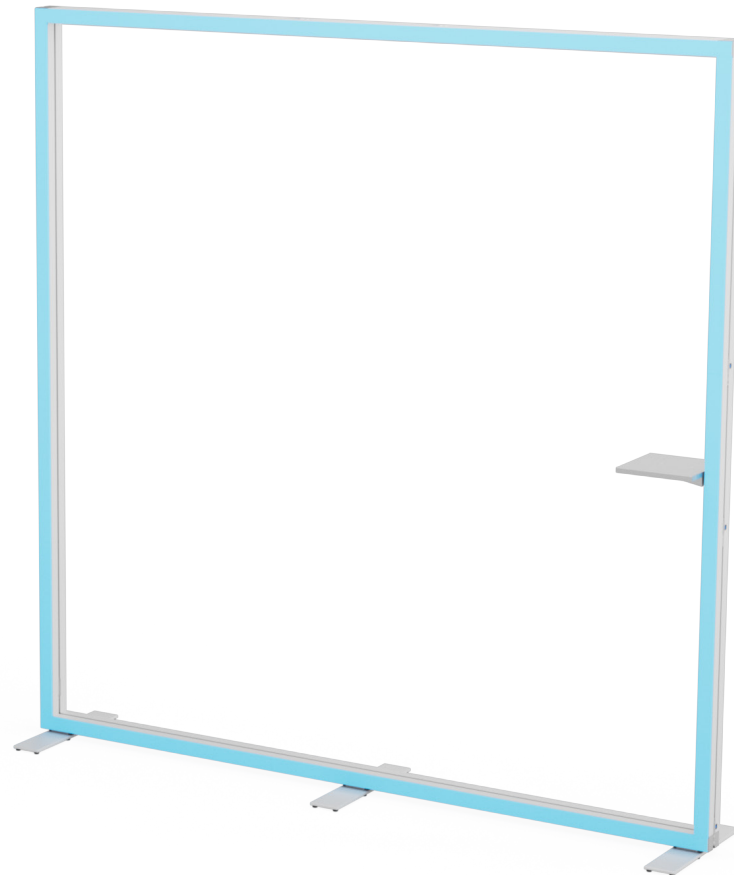

-LINE-300-300
-LINE-shelf-25

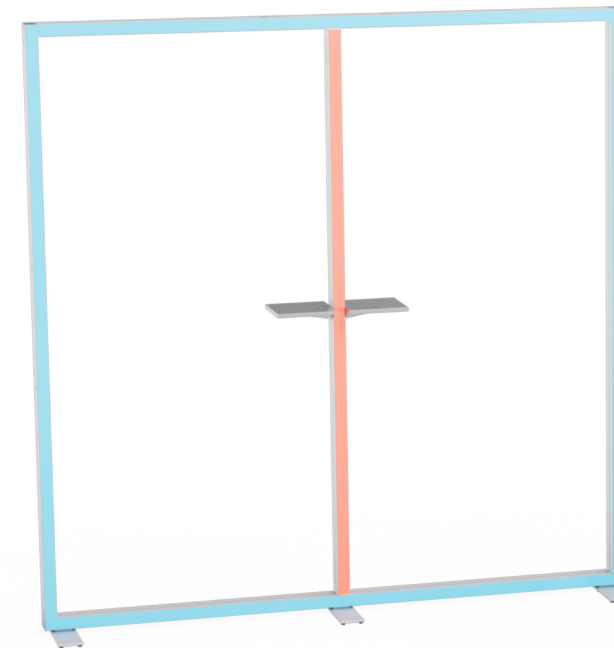

-LINE-300-300
-LINE-sup-pole-300
-2x LINE-shelf-25

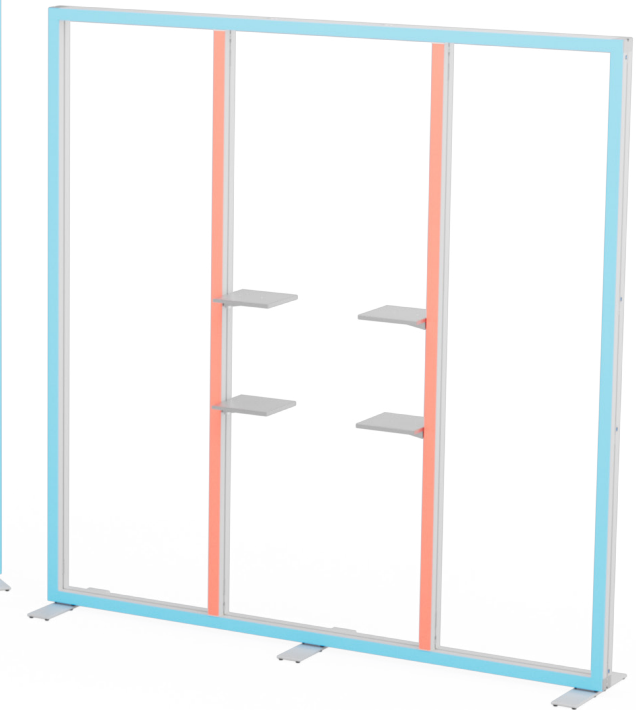

-LINE-300-300
-2x LINE-sup-pole-300
-4x LINE-shelf-25

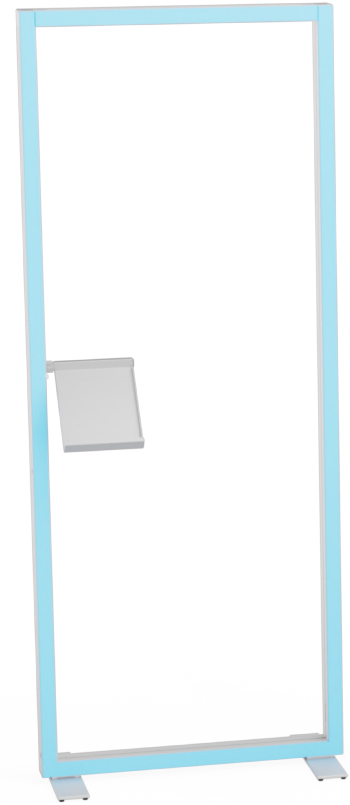
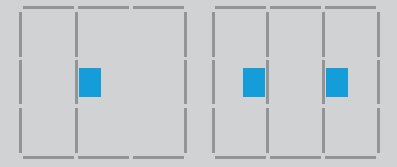
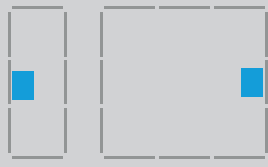

-LINE-stele-100-300
-LINE-brochure

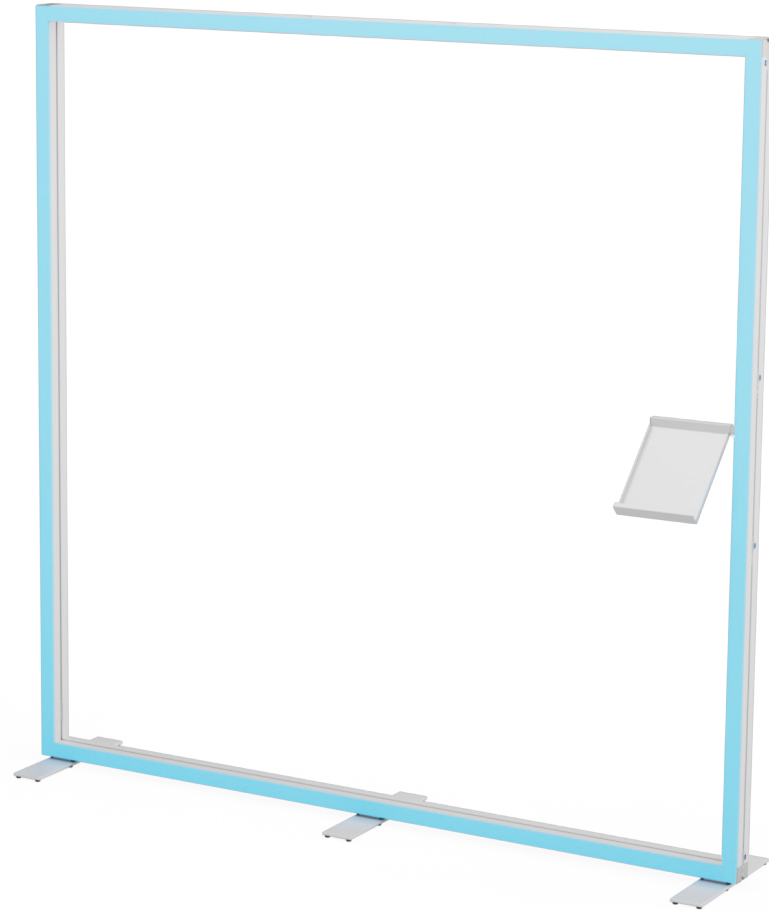

-LINE-300-300
-LINE-brochure

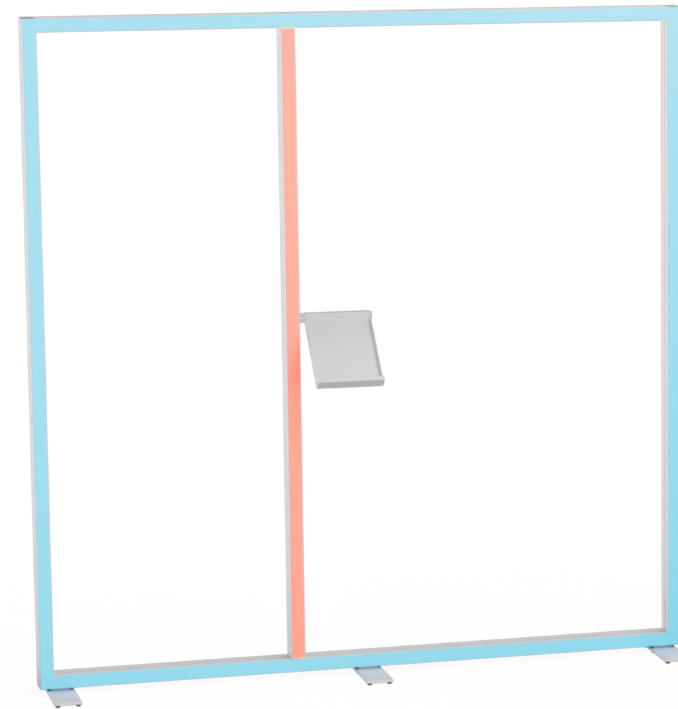

-LINE-300-300
-LINE-sup-pole-300
-LINE-brochure

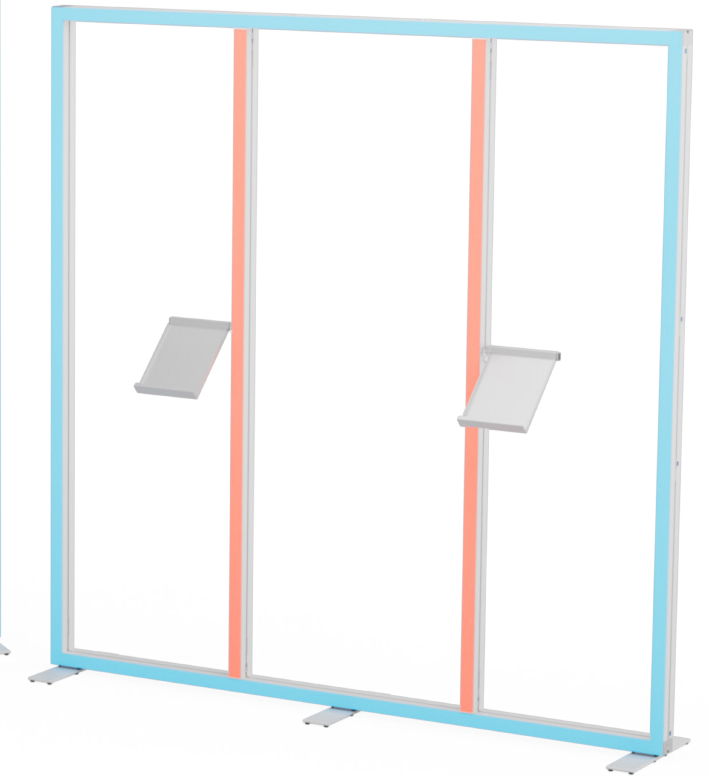

-LINE-300-300
-2x LINE-sup-pole-300
-2x LINE-brochure

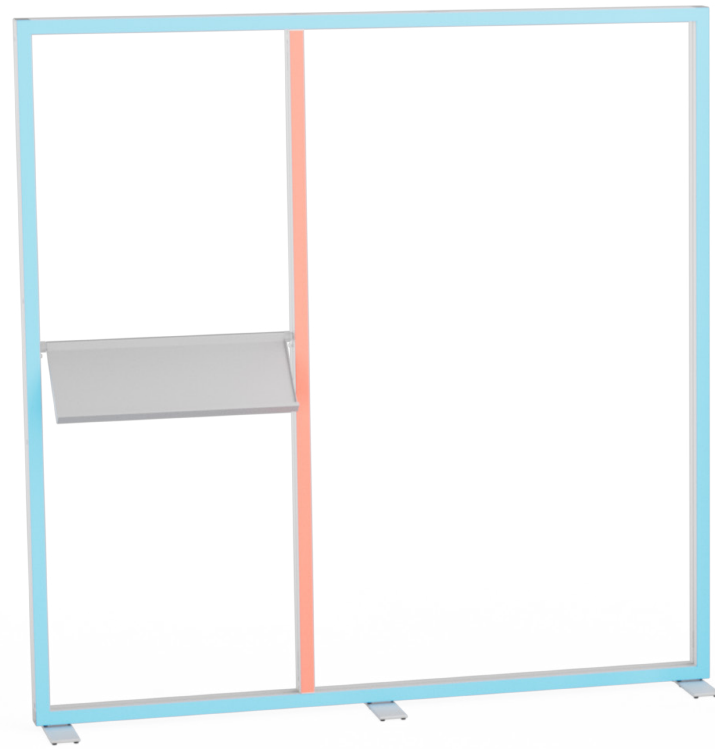
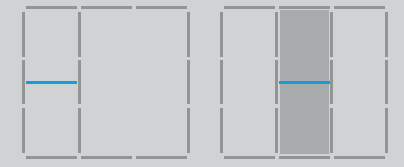
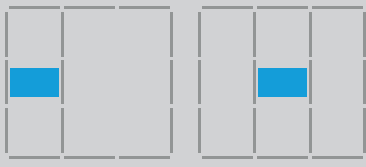

-LINE-300-300
-LINE-sup-pole-300
-LINE-shelf-84

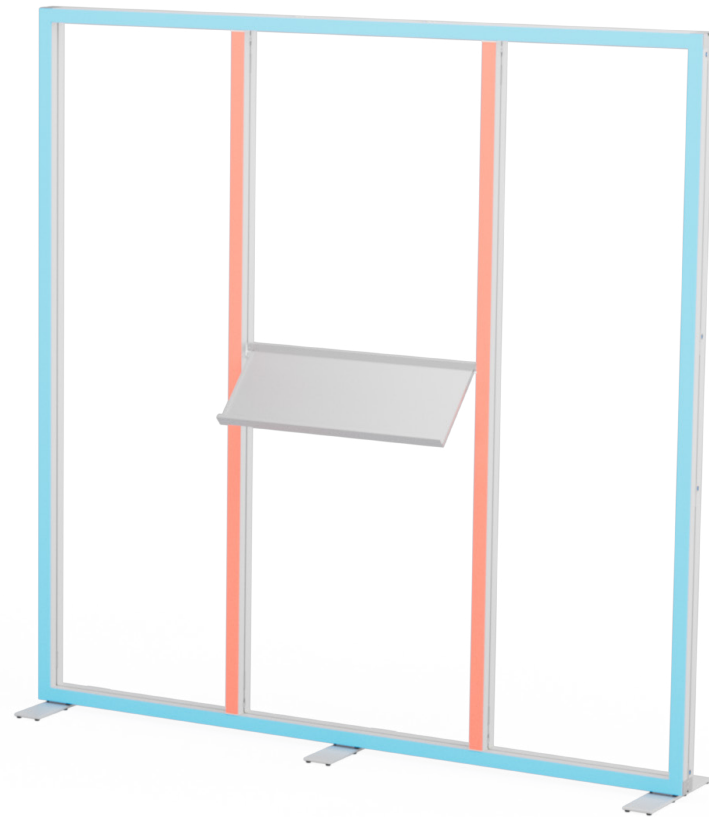

-LINE-300-300
-2x LINE-sup-pole-300
-LINE-shelf-84

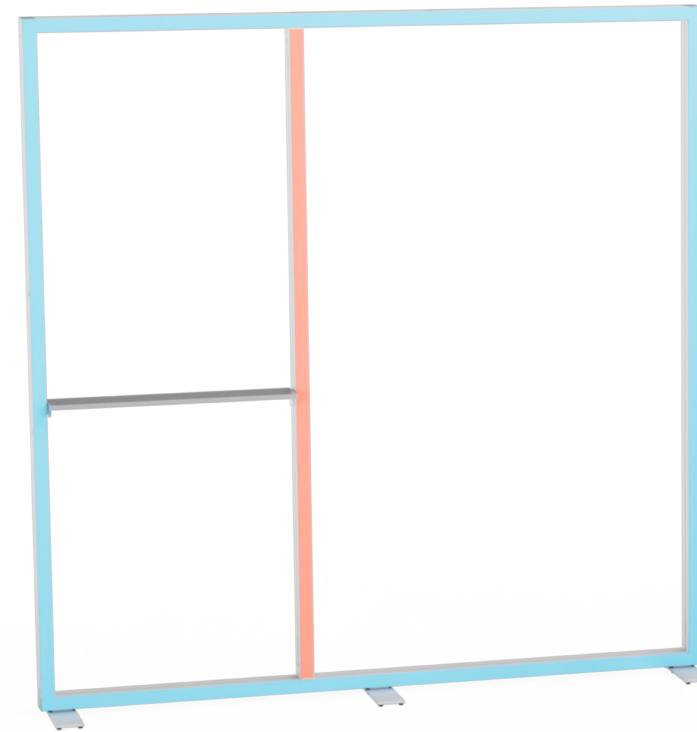

-LINE-300-300
-LINE-sup-pole-300
-LINE-shelf-89-15



-LINE-300-300
-2x LINE-sup-pole-300
-LINE-shelf-89-15

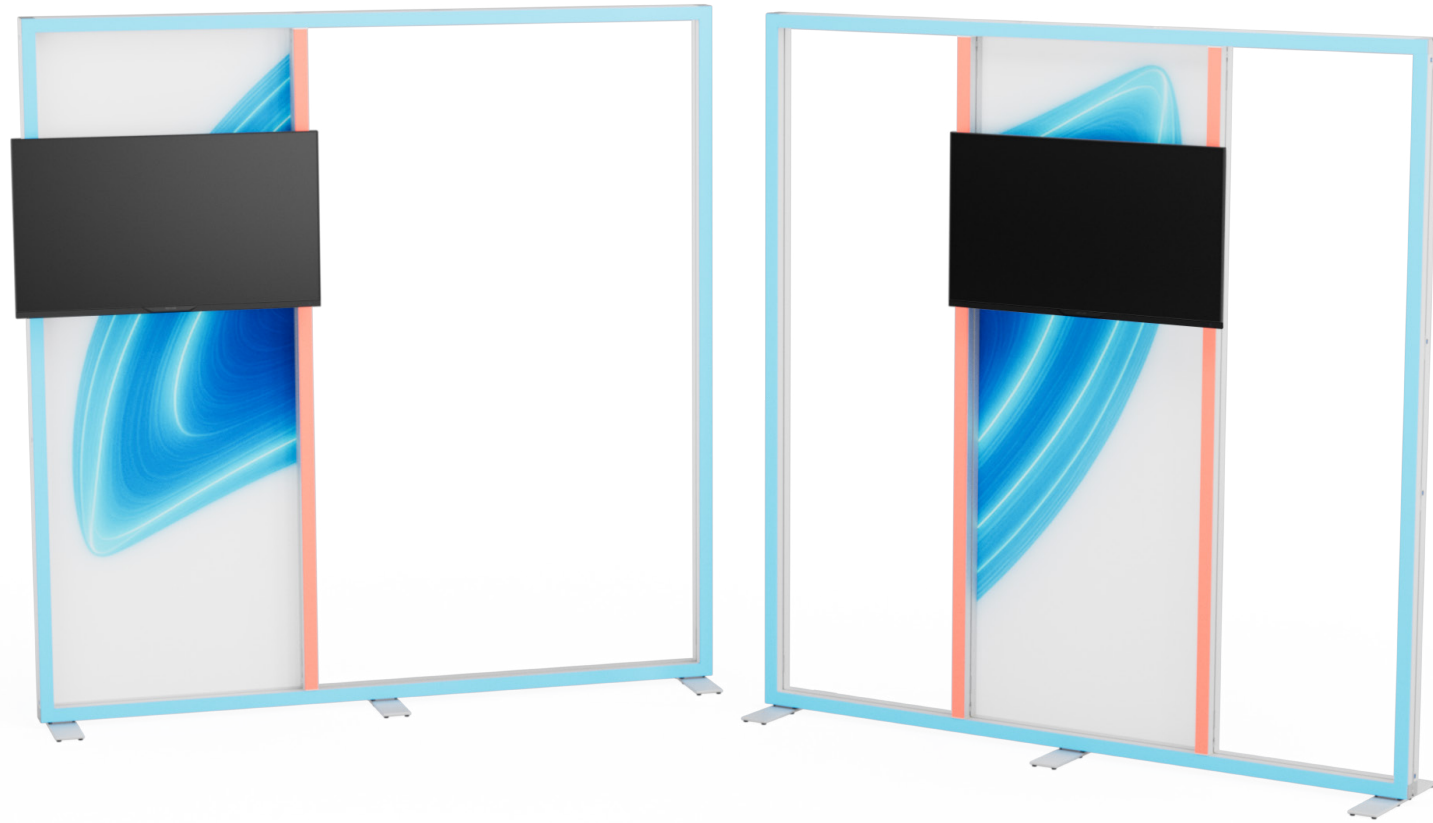
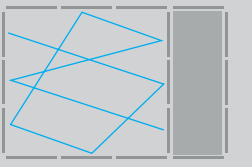
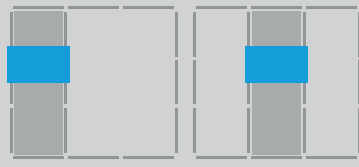

-LINE-300-300
-LINE-sup-pole-300
-LINE-stele-TV

-LINE-300-300
-2x LINE-sup-pole-300
-LINE-stele-TV

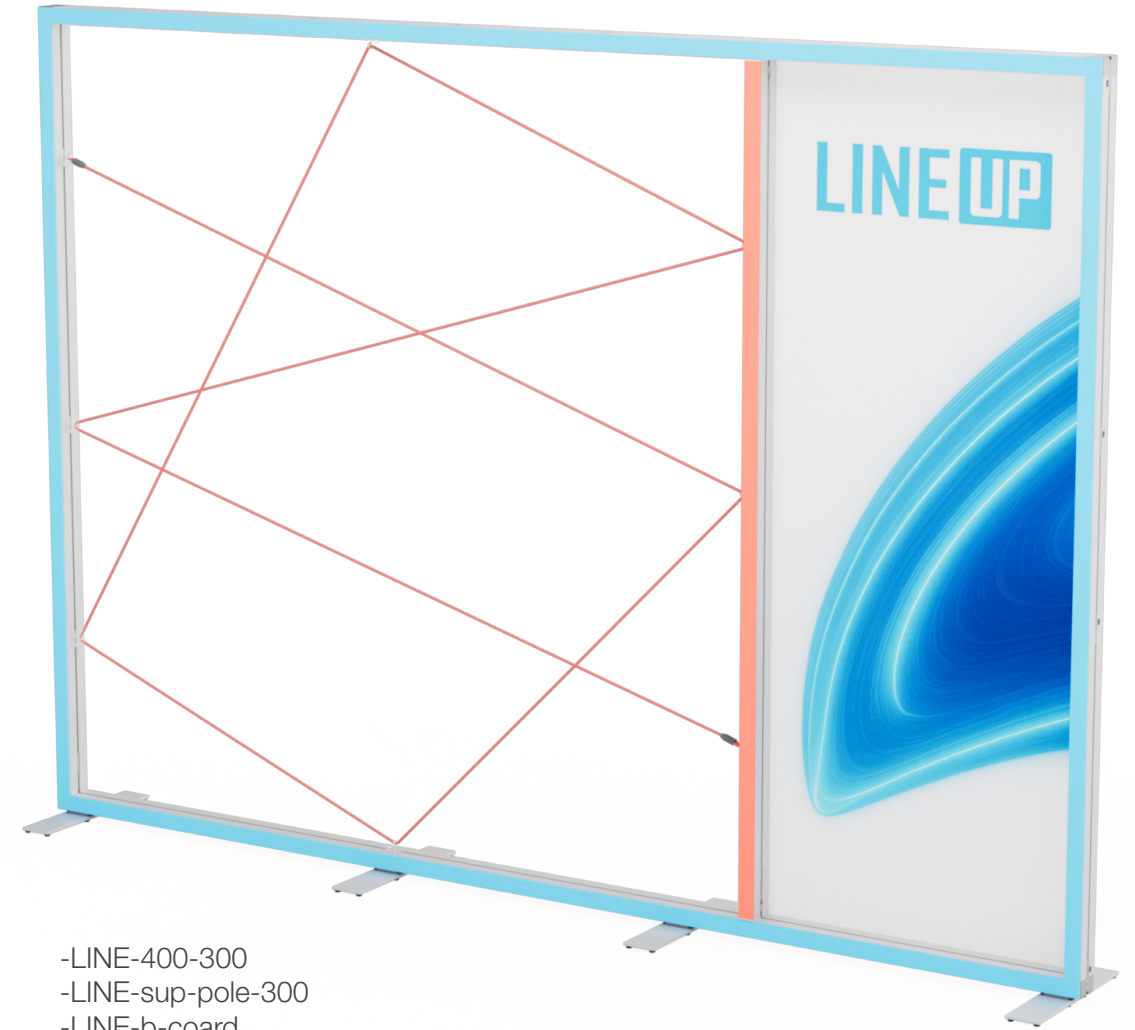

-LINE-400-300
-LINE-sup-pole-300
-LINE-b-coard

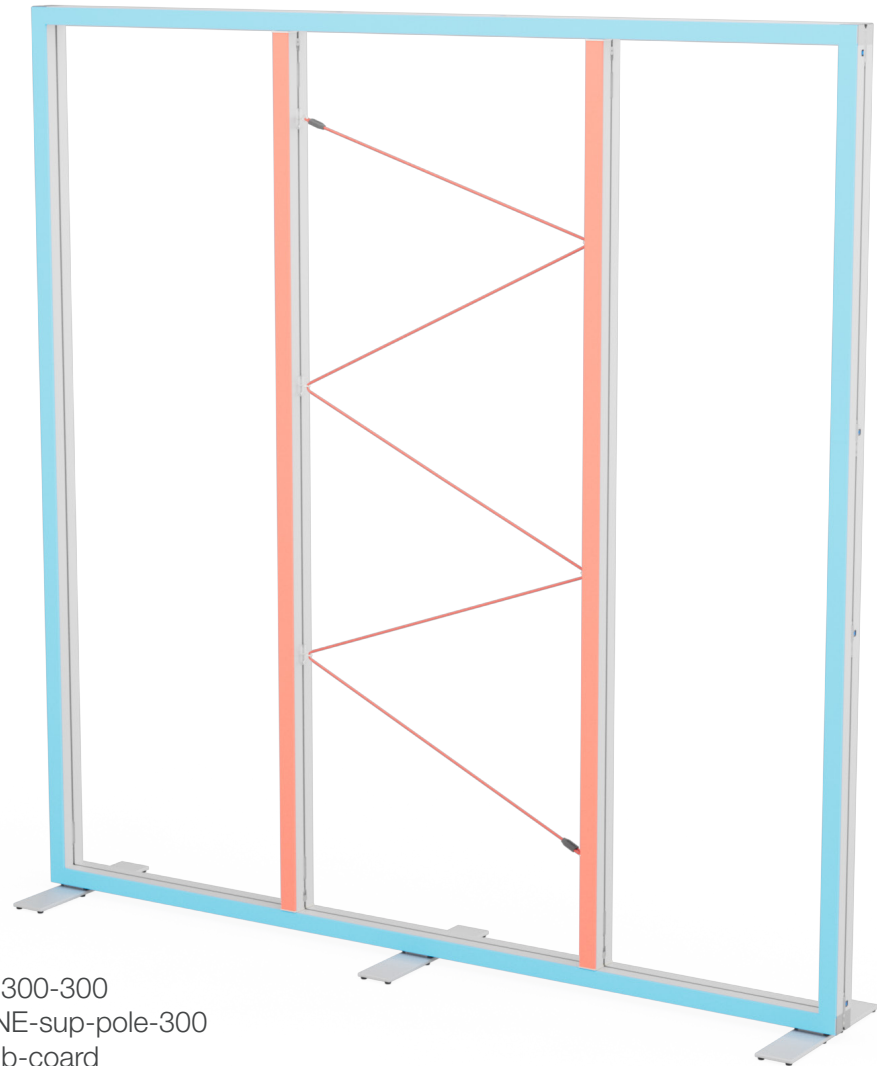
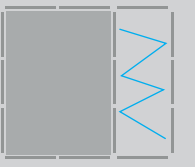
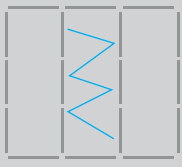

-LINE-300-300
-2x LINE-sup-pole-300
-LINE-b-coard

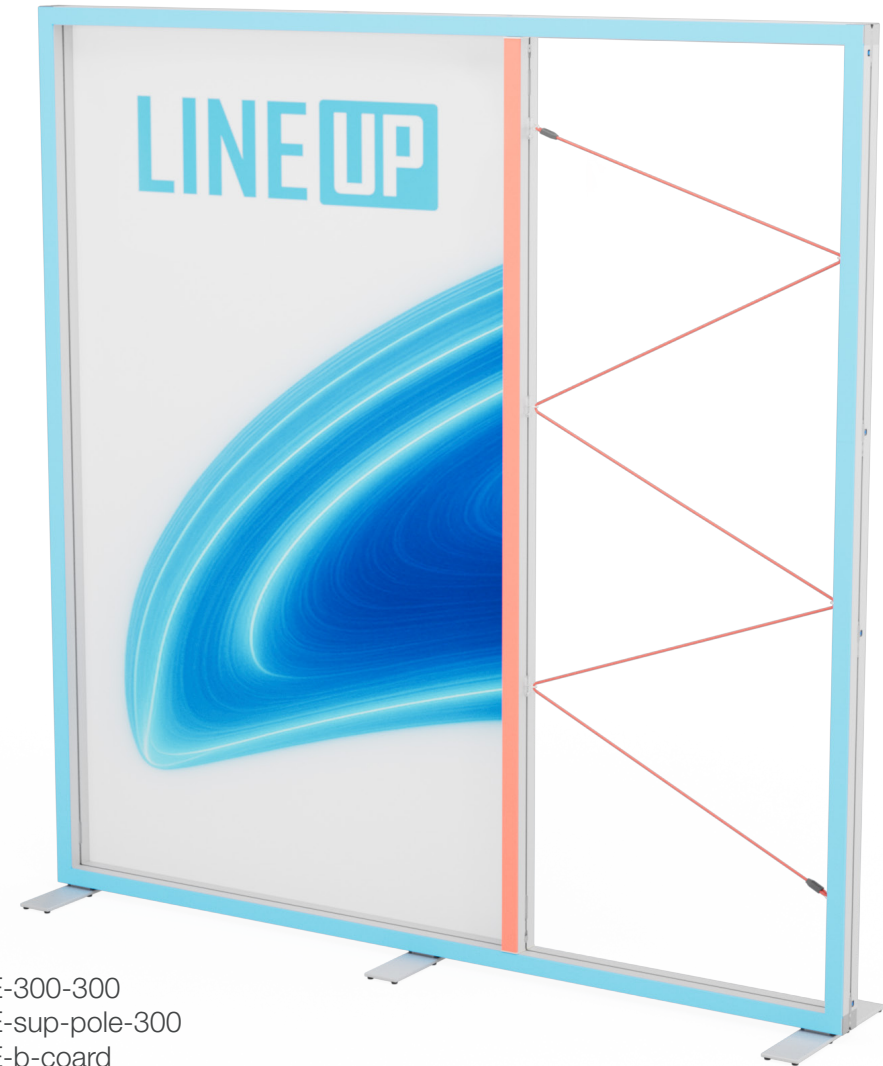

-LINE-300-300
-LINE-sup-pole-300
-LINE-b-coard

LINEUP

COUNTER
LED UP
MINI LED
PICUP
COUNTER ONE
BIG UP
COUNTER